



Planning Board – Monday, December 21, 2020, 6:30PM

AGENDA

NOTE: This meeting will be conducted using the online meeting platform, Zoom.* The public may view the meeting online by visiting www.zoom.us/join and enter the **Meeting ID: 857 8338 6440**. If you are unable to attend the meeting online, you may call the toll-free # (888) 475-4499 and enter the Meeting ID to listen to the meeting. More info on how to access this meeting is available at ci.keene.nh.us/planning-board. If you encounter any issues accessing this meeting, please call 603-209-4697 during the scheduled meeting time.

I. **Call to Order** – Roll Call

II. **Minutes of Previous Meeting** – November 23, 2020

III. **Advice and Comment**

Patricia Russell Park Conceptual Design – Andy Bohannon, on behalf of the City of Keene, seeks input on the proposed redesign of Patricia Russell Park (formerly Carpenter Field) located at 0 Carpenter St (TMP# 573-073-000). This property is 4.96-ac and is located in the Medium Density District.

IV. **Boundary Line Adjustment:**

S-08-20 – Boundary Line Adjustment – 89 Main St & 0 Commercial St – Applicant and owner Colonial Theatre Group Inc. proposes a boundary line adjustment between their property located at 89 Main Street (TMP# 575-008-000) and 0 Commercial Street (TMP# 575-010-000), which is owned by the City of Keene, NH. This adjustment would result in a transfer of 0.01-acres (370.5 sf) from the 1.6-acre lot located at 0 Commercial Street to the 0.36-acre lot located at 89 Main Street. Both properties are located in the Central Business District. The applicant is requesting a waiver from Standard III.C.5.b of the Planning Board's Site Plan and Subdivision Regulations that requires a survey plan showing all metes and bounds of the revised parcels be submitted as part of a boundary line adjustment application.

V. **Public Hearings:**

CONTINUED – SPR-963, Modification #3 – Site Plan – Sunoco Curb Cut Modifications, 345 Winchester St. – Applicant McFarland Johnson, Inc., on behalf of owner, RE Sandri TVE LLC, proposes to close an existing curb cut along Winchester Street and create a new curb cut along Old Key Road at the site of the Sunoco Gas Station located at 345 Winchester Street (TMP# 111-027-000). The site is 0.63 acres in size and is located in the Commerce District.

SPR-878, Modification #1 – Site Plan – Volkswagen Addition, 18 Production Ave. – Applicant and owner 18 Production Ave LLC proposes a 3,690-sf single-story addition to the existing 11,270-sf Noyes Volkswagen building located at 18 Production Ave (TMP# 110-004-000). The site is 2.14 acres in size and is located in the Industrial District.

VI. **Adoption of 2021 Meeting Schedule**

VII. **Community Development Director Report**

VIII. **New Business**

IX. **Upcoming Dates of Interest – December 2020**

- Joint PB/PLD Committee – Monday, January 11, 6:30 PM & TUESDAY, January 19, 6:30 PM
- Planning Board Steering Committee – January 12, 11:00 AM
- Planning Board Site Visits – January 20, 8:00 AM – To Be Confirmed
- Planning Board Meeting – January 25, 6:30 PM

**In Emergency Order #12, issued by the Governor pursuant to Executive Order #2020-04, which declared a COVID-19 State of Emergency, the requirement that a quorum of a public body be physically present at the meeting location under RSA 91-A:2, III(b), and the requirement that each part of a meeting of a public body be audible or otherwise discernible to the public at the meeting location under RSA 91-A:2, III(c), have been waived. Public participation may be provided through telephonic and other electronic means.*

34 view, the meeting by calling the toll-free phone number (877) 853-5257 and enter the Meeting ID
35 above. He noted that if someone is unable to access the meeting, they should call 603-209-4697.

36
37 Chair Barrett called the meeting to order at 6:30 PM and roll call was taken.

38
39 **II. Minutes of previous meeting** – October 26, 2020 Meeting

40 A motion was made by Mayor George Hansel to accept the October 26, 2020 minutes. The
41 motion was seconded by Councilor Michael Remy and was unanimously approved by roll call
42 vote.

43
44 **III. Boundary Line Adjustment:** S-07-20, Boundary Line Adjustment – 0 & 429 Old
45 Walpole Rd – MacKenzie-Casna BLA – Applicant Monadnock Land Planning on behalf of
46 owners, Warren & Arlie MacKenzie Living Trust and Robert & Barbara Casna, proposes a
47 boundary line adjustment between the parcels located at 0 Old Walpole Rd (TMP# 207-004-000)
48 and 429 Old Walpole Rd (TMP# 210-023-000). This adjustment would result in a transfer of
49 0.84-acres from the 8.29-acre lot located at 0 Old Walpole Rd to the 43-acre lot located at 429
50 Old Walpole Rd. Both properties are located in the Rural District.

51
52 **A. Board Determination of Completeness**

53 Senior Planner Tara Kessler addressed the Board and stated the applicant has requested
54 exemptions from providing a grading plan, landscaping plan, lighting plan, architectural
55 elevations, traffic report, and soils report, as this is a boundary line adjustment and no new
56 development is proposed. Staff recommends the Board grant the exemptions and accept the
57 application as complete. She added the Board did grant a waiver during its September meeting
58 from the requirement that all metes and bounds be surveyed for the 429 Old Walpole Rd parcel.
59 The applicant has delineated the metes and bounds for the area of the two parcels that would be
60 impacted.

61
62 A motion was made by Mayor George Hansel that the Board accept this application as complete.
63 The motion was seconded by Councilor Michael Remy and was unanimously approved by roll
64 call vote.

65
66 **B. Public Hearing**

67 Mr. David Bergeron of Monadnock Land Planning addressed the Board on behalf of the property
68 owners. 429 Old Walpole Road is owned by Mr. and Mrs. Casna (there is an existing single-
69 family house on this property). The proposed boundary line adjustment would transfer 0.84-acres
70 from the parcel at 0 Old Walpole Road to the property at 429 Old Walpole so that the driveway
71 for 429 Old Walpole Road would be located entirely on that parcel. The Casna property is
72 currently 43 acres. After the boundary line adjustment it would become 43.84 acres and the
73 McKenzie property which is currently 8.29 acres will become 7.45 acres. He went on to say all of
74 the McKenzie property at 0 Old Walpole Rd has been surveyed with metes and bounds around
75 the property. The area where the boundary line adjustment is going to take place has also been
76 surveyed. Mr. Bergeron noted a deed would be prepared based on the adjustment.

77
78 Ms. Somers asked how long this driveway has been in place. Mr. Bergeron stated the house was
79 built in the late 1970s so it has been in place for approximately 40-50 years.

80
81 Staff comments were next. Ms. Kessler noted the applicant did a thorough job reviewing the
82 proposal and since no new development is being proposed and no changes are being proposed to
83 the driveway, there is not much additional to report with respect to staff comments. She noted that

84 there are steep slopes present on both sites, but since the lots would maintain lots sizes required
85 by zoning for the rural district, both lots would maintain their development potential. With
86 respect to Comprehensive Access Management, no changes are proposed to the existing driveway
87 for 429 Old Walpole Road, and hence this standard appears to be met.

88
89 The Chairman asked for public comment, with no comments from the public the Chair closed the
90 public hearing.

91
92 **C. Board Discussion and Action**

93 A motion was made by Mayor George Hansel approve S-07-20, for a boundary line adjustment at
94 as shown on the plan identified as 0 & 429 Old Walpole Road, as shown on the plan identified as
95 “Boundary Line Adjustment Plan Prepared for Warren A. & Arlie M. MacKenzie Living Trust
96 and Robert & Barbara Casna Valley View Drive City of Keene, County of Cheshire, State of
97 New Hampshire” prepared by David Mann Survey at a scale of 1” = 50’ on October 16, 2020
98 with the following condition:

99
100 1. Owners’ signature appears on plan.

101
102 The motion was seconded by Councilor Michael Remy and was unanimously approved by a roll
103 call vote.

104
105 **IV. Public Hearings:**

106 SPR-963, Mod. 3, Site Plan – 345 Winchester St – Sunoco Curb Cut Modifications – Applicant
107 McFarland Johnson, Inc., on behalf of owner, RE Sandri TVE LLC, proposes to close an existing
108 curb cut along Winchester Street and create a new curb cut along Old Key Road at the site of the
109 Sunoco Gas Station located at 345 Winchester Street (TMP# 111-027-000). The site is 0.63 acres
110 in size and is located in the Commerce District.

111
112 **A. Board Determination of Completeness**

113 Senior Planner, Tara Kessler stated the applicant has requested exemptions from providing a
114 grading plan, lighting plan, and a traffic report, and staff has determined granting the exemptions
115 will have no bearing on the merits of the application and recommend to the Board that they
116 accept the as complete.

117
118 A motion was made by Mayor George Hansel that the Board accept this application as complete.
119 The motion was seconded by Councilor Michael Remy and was unanimously approved by roll
120 call vote.

121
122 **B. Public Hearing**

123 Mr. Eugene McCarthy of McFarland Johnson addressed the Board on behalf of the applicant.
124 Mr. McCarthy stated the modification to this project is because of a city project to reconstruct
125 Winchester St. He noted the existing traffic signal at the intersection of Winchester Street, Key
126 Road and Riverside Plaza is to be replaced by a roundabout. The site that is the subject of this
127 application is 345 Winchester St, the current Sunoco Gas Station and Sandri convenience store.
128 This site is located at the southwest quadrant of this intersection.

129
130 Mr. McCarthy stated there are currently three driveway curb cuts on the subject parcel; One off
131 Key Road to the north and two off Winchester Street to the east. As part of the proposed
132 roundabout design, due to proximity to the roundabout, the northern curb cut along Winchester

133 Street will need to be closed off. To mitigate the loss of this driveway, a new driveway is being
134 proposed on the southern side of the property at Old Key Road.
135 Mr. McCarthy noted Old Key Road is a one-way eastbound roadway.

136
137 He noted there is existing landscaping on the site which will be impacted by this project. The
138 landscaped island to the far north, adjacent to the driveway on Key Rd, will be reconfigured and
139 some of the plantings will be transplanted. Currently, there is a narrow strip of landscaping
140 between the gas pump station area and Winchester St. The applicant is proposing to remove this
141 island and replace it with a travel aisle, to create a bypass lane adjacent to the gas pumps to help
142 with onsite circulation. Along the right of way on Winchester Street there will be new island
143 installed that will be planted with grass.

144
145 Mr. McCarthy referred to the most recently approved landscape plan for this site. He noted some
146 of those plantings have been removed since this plan was approved. The plantings along Key
147 Road have been replaced, some of the ones along Key Road have been removed. Mr. McCarthy
148 reviewed which existing plants would be relocated on the site and which would be removed. He
149 referred to the drawings showing these landscaping changes, which was submitted with the
150 application, in his presentation.

151
152 Staff comments were next. Ms. Kessler addressed drainage first and noted the applicant has
153 submitted a drainage letter from a NH licensed engineer which indicates that there will be a
154 diminimus increase in the amount of impervious area to the site (2.2% increase). The increase
155 that is anticipated in stormwater will remain onsite. As part of the roundabout project there will
156 be a storm water pond installed across the street and any water coming off this site into the right
157 of way will be treated in that pond. Staff feels the drainage standard has been met.

158
159 With respect to snow storage, the proposed plan does not alter the existing snow storage plan.
160 This standard appears to be met.

161
162 With respect to landscaping, staff would like to see a revised plan showing a more detailed
163 description of where the relocated plantings will be onsite.

164
165 Ms. Kessler referred to the screening standard. She noted that there were a number of ink berry
166 plants approved as a screening for the gas pump stations in the original site plan for this business.
167 She noted that the applicant is proposing to remove these shrubs to provide more room for the
168 travel lane. Ms. Kessler noted that the Board may consider asking the applicant to replacing this
169 landscaped screening.

170
171 With respect to traffic and comprehensive access management, Ms. Kessler noted that the
172 removed curb cut proposed by the Applicant will serve to improve the safety and access of
173 vehicles entering and exiting the site with the proposed roundabout. As indicated by the
174 Applicant, maintaining the one-way in and one-way out at each of the driveways (including the
175 proposed driveway) will reduce vehicle conflict. The introduction of a new travel isle giving
176 motorists the opportunity to move around the pump islands will be an improvement in access
177 management for this site. Ms. Kessler note the sidewalk along Winchester Street in front of this
178 site will be replaced as part of the roundabout project.

179
180 Chair Barrett referred to the ink berries along Winchester Street and asked whether the Board's
181 screening standards would typically apply to gas stations. Ms. Kessler stated the Planning
182 Board's Development Standards do not specifically require screening for this use but they do

183 encourage screening of equipment, dumpsters etc. She noted it was not clear in the minutes from
184 when this site plan application first came before the Board whether this landscaping was
185 something proposed by the original applicant or requested by the Board at that time. Ms. Kessler
186 noted if this was a new proposal the standard would be met unless the Board felt additional
187 screening was required for aesthetic reasons from Winchester Street. The Chairman clarified that
188 staff is recommending a revised landscape plan be submitted to be reviewed and approved
189 administratively. Ms. Kessler answered in the affirmative and added this plan would serve as a
190 guide for staff to review the site to make sure the proposed plantings have been installed
191 according to the plan.

192

193 The Chairman asked for public comment next.

194

195 Mr. Michael Behn, President of Sandri Companies, owner of the property at 345 Winchester St,
196 addressed the Board. Mr. Behn stated they were presented by three options to deal with the
197 location of the roundabout which they continue to oppose. Mr. Behn stated they were not
198 properly notified of hearings as it relates to the Winchester Street Reconstruction Project and the
199 offers made to them by the City were not acceptable to them. Mr. Behn noted the curb cut they
200 are losing is the primary entrance to this site. He indicated that what is being proposed would
201 have a terrible impact on the store, the traffic entering the store, and traffic circulation. He
202 explained vehicles travelling on Winchester Street will have to do a U-turn to get to the fueling
203 stations, and another U-turn to exit the site or travel to Key Road to exit the site.

204

205 City Engineer Don Lussier addressed the Board next. Mr. Lussier stated the city would need to
206 acquire a certain amount of land from the Sandri property to be able to construct this roundabout.
207 Mr. Lussier indicated staff has been working with this applicant to try and mitigate the proposed
208 impact to their property. Ms. Kessler clarified with Mr. Lussier that there will be a public hearing
209 on the road layout for Winchester Street. Mr. Lussier stated the item before the Planning Board is
210 to seek approval for the portions of this project that are outside the City's right of way – e.g. the
211 addition of a new driveway and changes to landscaping. Parallel to this process the City Council
212 is considering their authority to use eminent domain to acquire that portion of land. There will be
213 a public hearing on this topic before the City Council on December 17. The Council may or may
214 not elect to exercise its eminent domain authority. If they choose not to exercise their eminent
215 domain authority, the site plan will become unnecessary, staff will be back with a different
216 application or it simply would not happen.

217

218 Ms. Russell Slack clarified the Board is moving with the site plan application before the eminent
219 domain process has been concluded. Mr. Lussier explained the changes being approved through
220 the site plan modification are to mitigate some of the impacts the roundabout project would have
221 on the applicant's property. He added the city's infrastructure project can move forward without
222 the new proposed driveway. Mr. Lussier went on to say, if the Council decides not to acquire the
223 property needed for the roundabout there would need to be significant redesign to locate the
224 roundabout.

225 Ms. Russell Slack asked whether the state was involved in any of the design being proposed to
226 the landowner. Mr. Lussier's answered in the negative but added the state was involved in the
227 review and approval of the roundabout and the project is being funded through federal highway
228 money. He noted the NHDOT has no purview on whether the city grants a driveway on a city
229 street. Ms. Russell Slack stated she was concerned about the access to this site.

230

231 Mr. Lussier added when this property was assessed it was with the assumption the driveway will
232 be added on the south side of the parcel. If the Board does not approve this site plan application

233 the city's will have to reconsider the valuation of the impacts of the project and the compensation
234 could change.

235
236 Attorney Michael Hanley representing the applicant addressed the Board next. He noted he
237 wanted the Board to understand his applicant is moving forward without prejudice to its position;
238 it is a voluntary position. He added the proposal before the Board is the best of three very bad
239 proposals presented to the applicant.

240
241 Ms. Gail Somers clarified a future decision by the Council might make the Board's decision
242 irrelevant. Ms. Kessler clarified the Board's decision would be conditioned upon the City
243 Council's decision regarding the modified road layout of Winchester Street. She further stated
244 planning staff was unaware of the applicant's opposition to the proposed site plan application and
245 added that site plan application was signed by the owner of Sandri.

246
247 Mr. Jeffrey Pechulis of ASP Land Development Services, Traffic Analyst and Site Planner
248 addressed the Board next. Mr. Pechulis stated his understanding is that this roundabout project
249 was considered to address traffic congestion and to address bicycle and pedestrian safety on
250 Winchester Street. He noted, based on the engineering report submitted, it was identified the
251 traffic signal adjacent to this site experienced 25 accidents in an eight year period (three accidents
252 per year). During this same time period the roundabout south of this intersection has experienced
253 301 accidents (38 accidents per year). Mr. Pechulis noted the concern is the same accident pattern
254 will continue at this roundabout impacting the applicant's business.

255
256 With respect to the site plan, Mr. Pechulis stated the proposed driveways are not the ingress and
257 egress plan this site was designed for. With the layout of the canopy, fueling stations, traffic flow,
258 parking and access to and from the store, the site was designed with three driveways – especially
259 on Winchester Street, a right turn in north of the fueling stations and a right turn out south of the
260 fueling stations. The elimination of the primary driveway will have an overall impact on the
261 project and has the potential to spill vehicles out on to Winchester Street. Without the north
262 driveway, customers will be required to enter the site using the south driveway on Winchester
263 Street, and as was mentioned, take a U-turn from Winchester Street, change their direction to
264 access the fueling stations under the canopy. He added this maneuver can be accommodated if
265 there are no vehicles blocking the egress at that same driveway. Also, passenger vehicles are the
266 only ones that can enter the site under the proposed turning radius. Anything, bigger than a
267 passenger vehicle, such as a box truck, a large pickup truck, will not be able to make the turning
268 radius to enter the fueling stations. Mr. Pechulis noted this would be a tremendous impact to this
269 site and to Winchester Street as well as.

270
271 The Sunoco Station currently sells diesel which attracts oversized vehicle. If large vehicles are
272 trying to enter this site and there is a vehicle exiting the south than large vehicle will have to wait
273 on Winchester Street until that vehicle exits the site. Once a large vehicle enters the site, there is
274 inadequate turning radius for vehicles to head south bound. There is a driveway on Key Road, but
275 based on the engineering study that rotary will be expected to have five to six vehicles stacked
276 past this driveway on a regular basis; vehicle queues in excess of 130 feet will further reduce the
277 ability to circulate around the site.

278
279 Mr. Pechulis went on to say in the proposed site plan there is reference to an expanded bypass
280 lane between the canopy and the Winchester Street right of way (five feet). Mr. Pechulis stated
281 for two vehicles to be positioned in that area, this widening will have to be in excess of ten feet
282 closer to 13 feet. There will also be vehicles stacked at the south driveway trying to exit the site.

283 Mr. Pechulis noted without a traffic light at the Walmart or Key Road intersection, there will be
284 no stop in traffic flow for vehicles to exit these sites. With a rotary and a continuous flow of
285 traffic it will prohibit traffic from leaving this site.
286

287 Mr. Pechulis stated the site plan also does not refer to the elimination of the northern driveway
288 and adding traffic to the southern driveway when fuel delivery is taking place. During such times,
289 traffic will be backed up entering and exiting this site because of the tanker. He added that an
290 additional driveway at Old Key Road is acceptable but is not an adequate exchange for
291 elimination of the north driveway. He added this plan does not address congestion issues in the
292 future. He added the traffic report is only addressing traffic concerns during Saturday retail peak
293 hours but not traffic during weekday commuter peak hours. Mr. Pechulis also provided that there
294 is no safety precautions being provided for pedestrians or bicycles to cross the street in a rotary
295 situation.
296

297 Mr. Lussier reminded the Planning Board the nature of the Winchester Street reconstruction
298 project is beyond the scope of the discussion tonight. The MSFI Committee heard the issues and
299 recommended the roundabout option in 2017 as a safer option compared to the intersection. With
300 respect to the driveway onto Old Key Road, he stated he was under the impression the applicant
301 was in support of this option. Mr. Lussier stated there may be a question whether the applicant
302 wishes to withdraw the application, or if the Board may choose to wait until the Council's
303 decision on December 17.
304

305 Mr. Behn stated when they signed the application, they were not given many options. It had been
306 decided the city was going to take the land and three options were presented to them and the one
307 before the Board is the best of those three options. He stated this does not mean they feel this plan
308 will work and felt the site will be negatively impacted. He noted to a financial analysis that has
309 been undertaken based on these changes. Mr. Behn stated they signed the application because
310 they felt they did not have any other choice and did not want to give the impression that the
311 approval of this site plan application tonight equates to the applicant being in favor of the city
312 taking the land. He expressed frustration with not being notified about this project until earlier
313 this year.
314

315 With no further public comment, the Chairman closed the public hearing.
316

317 Ms. Kessler stated staff is in a unique position, in that, they were under the impression when the
318 applicant submitted the application that the owner signed this application in support of what was
319 proposed for the site. Given the testimony received this evening, she noted that staff's
320 recommendation is to continue the public hearing on this application to the December 21 meeting.
321

322 Ms. Russell Slack stated she was in agreement with continuing this application and added she was
323 having a hard time visualizing what the issues are not having something in front of her. Vice-
324 Chair Cusack stated he would like to wait for the city to come to some type of agreement with the
325 applicant or for the Council to weigh in on this issue before moving forward with a site plan
326 application. Ms. Somers agreed she too felt this item should be continued based on the sequence
327 of events that need to happen.
328

329 C. Board Discussion and Action

330 A motion was made by Mayor George Hansel to continue SPR-963, Modification #3 to the
331 December 21, 2020 Planning Board meeting. The motion was seconded by Councilor Michael
332 Remy and was unanimously approved by roll call vote.

333
334
335
336
337
338
339
340
341
342
343
344
345
346
347
348
349
350
351
352
353
354
355
356
357
358
359
360
361
362
363
364
365
366
367
368
369
370
371
372
373
374
375
376
377
378
379
380
381

V. Presentation on Draft City of Keene Sustainable Energy Plan

Planner Mari Brunner addressed the Board next and stated the Sustainable Energy Plan is based on goals adopted by the City Council in January 2019. The goals are to achieve 100% renewable energy for electricity by 2030, and for thermal energy and transportation energy by 2050. She noted a copy of the Resolution is available online.

Ms. Brunner went on to say this has been a two year process; it started in the winter and spring of 2019, when the energy and climate committee worked with staff on public outreach and conducting interviews with stakeholders. They conducted focus groups in the summer of 2019 with local landlords and a workshop was held in October 2019. There were volunteers who were trained using material provided to them and they conducted meetings in the community. There was a resident energy cost survey done in winter and spring of 2020. There were also focus groups conducted with businesses and larger institutions. In summer of 2020, a project website was launched, staff conducted a few online surveys, and in October 2020 the last Community Forum was conducted.

Ms. Brunner then went over the planning process. They started with collecting data and developing energy baselines for electricity, thermal, and transportation. The energy and climate committee looked at potential strategies and actions to reach the City’s energy goals. They used the feedback to prioritize strategies, actions, and tools. Staff and the committee has been working on identifying best practices, relevant examples, and implementation steps for each priority actions. The next step would be to incorporate feedback from public and submit the plan to City Council.

The vision statement for the plan reads as follows:

“In 2050, Keene will be a thriving and resilient community powered by affordable, clean, and renewable energy. All electricity and energy used for heating, cooling, and transportation will come from renewable energy sources.”

The energy and climate committee felt there was a subset of renewable energy that was even more beneficial, which has fewer detrimental impacts. Ms. Brunner noted these include are wind, solar, biomass, geothermal, biogas and low impact hydropower.

The overall plan is structured around four pathways which are being referred to as a Roadmap to 2050:

1. Reduce energy use.
2. Generate and store renewable energy locally (Generating renewable resources in Keene can create jobs locally and keep money circulating in the community)
3. Switch remaining energy demand to renewable sources
4. Conduct ongoing advocacy and information sharing – to make sure people are aware of the options and to address the existing barrier.

The four pathways were applied to three goals. For Electricity, the priorities identified were to create a Community Power Program, Virtual Power Purchase Agreement, Solar PV & EV Ready Guidelines, Renewable Energy Loans, and Pilot Battery Storage Program. The city is actively pursuing the Community Power Program and there is a community power committee that has been meeting.

382 For Thermal, adopting a Home Energy Labeling program, adopting a Benchmarking Ordinance,
383 enhance existing weatherization programs and create new ones, run a Heatsmart Campaign and
384 create Renewable District Heating System.

385
386 For Transportation, the four pathways were to reduce vehicle miles traveled, accelerate shift to
387 electric vehicles, promote efficient growth patterns, and conduct continued advocacy and
388 information sharing.

389
390 Some of the priority strategies identified for transportation are to accelerate the shift to electric
391 vehicles, enhance Complete Streets Program, support and expand public transit (City Express),
392 support the multi-modal transportation center (currently there is a study being undertaken by
393 Southwest Regional Planning Commission), and advocacy for funding public transportation,
394 active transportation, and alternative fuel vehicles.

395
396 A draft plan is posted online at www.KeeneEnergyPlan.com. The Energy & Climate Committee
397 will discuss revisions to this draft at their meeting on December 2, 2020 at 8:00 am (via Zoom).
398 The revised plan will be submitted to City Council in December.

399
400 **VI. Community Development Director Report**

401 Ms. Kessler addressed this item – she indicated an email notice was sent to all Planning
402 Board members regarding an upcoming Department of Transportation meeting on December 1 at
403 6:30 pm. The department will be discussing areas proposed for compensatory mitigation
404 associated with the development of the NH Routes 9/10/12 intersection near Monadnock
405 Marketplace.

406
407 **VII. New Business**

408 None

409
410 **VIII. Upcoming Dates of Interest –November 2020**

- 411 • Joint PB/PLD Committee – December 14, 6:30 PM
- 412 • Planning Board Steering Committee – December 8, 11:00 AM
- 413 • Planning Board Site Visits – December 16, 8:00 AM – To Be Confirmed
- 414 • Planning Board Meeting – December 21, 6:30 PM

415
416 The meeting adjourned at 8:15 pm

417
418 Respectfully submitted,

419
420 Krishni Pahl
421 Minute Taker

422
423 Reviewed by: Tara Kessler, Senior Planner

City of Keene
New Hampshire

MEMORANDUM:

TO: The Planning Board

FROM: Community Development Staff

DATE: December 11, 2020

SUBJECT: Patricia Russell Park Concept Design

Background:

Please find attached three documents related to the Advice & Comment for the Patricia Russell Park Conceptual Design that will be presented by Andy Bohannon from the Parks & Recreation Department. This is the third item on the meeting agenda.

- 1 Wayfinding signage at Cheshire Rail Trail guides users to the park.
- 2 Existing sidewalk along Water St. provides pedestrian connection between Cheshire Rail Trail and the park. Consider adding a new section of sidewalk between Water St. and the park along Carpenter St.
- 3 Coordinate with building owner to use existing parking area during events.
- 4 Work with building owner to house solar panels on roof to supply power for lighting and surveillance cameras.
- 5 Mural/ Art installation on existing building wall (coordinate with building owner).
- 6 Maintenance gate/ emergency access to the park/ overflow parking entry.
- 7 Event drop off/ pick up & emergency park access lane.
- 8 Coordinate with building owner to use existing grass area for overflow parking during events (28 potential spaces).
- 9 New chain-link fencing.
- 10 8-foot wide multi-use trail moves along the park perimeter – experiencing multiple use areas.
- 11 Potential location for event tents.
- 12 Shade trees define property line.
- 13 New location for buried stormwater pipe.
- 14 Stormwater infiltration area makes partial use of existing "lawn"/ low-value wetland area, and receives stormwater from local pipe buried below athletic field – filtering the adjacent by neighborhoods stormwater prior to entering Beaver Brook.
- 15 Butterfly/pollinator gardens.
- 16 Multi-level giant tree/log "backless" seating elements.
- 17 Adirondack seating in lawn areas surrounded by flowering perennials, and new trees and plantings along the brook.
- 18 Lower destination area (flood-able) allows children to get close to Beaver Brook – boulders create micro retaining elements within the floodplain.
- 19 Creation of a floodplain shelf allows flood water to spread, slowing velocities during rain events and provides a lower riparian tier for new herbaceous communities – increasing habitat for new fauna.
- 20 Rip-rap pedestrian crossing.
- 21 Storm water infiltration areas with high level overflow through cobble rip-rap into Beaver Brook.
- 22 Open-air destination pavilion. Access provides a great place to gather and listen to Beaver Brook roll through the cobble riffles. Provide a blue light safety system in pavilion and place picnic tables around the pavilion in lawn areas.
- 23 Re-graded hillside lessens severity of steep banks. Place boulders, surrounded by vegetation, on hillside for seating for the adventurous explorer.
- 24 Remove invasive Japanese knotweed, etc. along bank and restore hillside with native riparian plantings (include trees to shade brook).
- 25 Cobble riffles in the stream channel reduce turbidity, slow water velocity, and oxygenates brook for aquatic species.
- 26 Creation of a 4-foot wide low flow channel.
- 27 New ADA accessible walkway into park.
- 28 Pedestrian wayfinding signage on Harrison Street guides visitors to eastern park access.
- 29 +/- 60-foot by 60-foot play scape area.
- 30 +/- 30-foot by 50-foot play scape area for swings.
- 31 Gravel/stone dust passive seating areas under flowering trees reminiscent of a small Paris courtyard space.
- 32 Bocce ball court and pergola with lighted charging stations with table and chair seating.
- 33 Decorative "street print" paving identify areas of pedestrian crossing.
- 34 Destination gathering space with open meeting space and curved walls/seating, open-air picnic pavilion, and varied seating along the field. Provide fencing and gate access to onto open lawn area.
- 35 Colorful shade sails above picnic area and play area.
- 36 Passive plaza space (waiting space) outside of bathrooms. Place large granite or wood block seating in space.
- 37 Large berry producing shrub mass and artistic bluebird boxes provides habitat and food source as well as screening for neighbors.
- 38 Bathroom facility and recreational storage. Decorative wood guardrail/fencing with granite posts.
- 39 Maintenance/emergency/police monitoring access road with gate, (2) additional parking spaces for parking (non-event).
- 40 New curbed islands protect existing Linden trees. Create micro-depressions in islands that receive stormwater from Carpenter Street.
- 41 Accessible parking areas (provide signage and detectable warning strips).
- 42 New formalized asphalt parking spaces, while protecting existing trees (24 spaces).

- 43 Main park entrance with colorful "gateway" signage, bollards, and bike parking. Place an informational kiosk as well.
- 44 Central destination plaza with large sculpture, seating, and blue light safety system.
- 45 +/- 40-foot x 20-foot covered bleacher system.
- 46 Decorative wood guardrail/ fencing with granite posts.
- 47 (3) passive "chill" areas, complete with removable hammocks and access to multi-use path.
- 48 Expanded double stacked parking increases available parking spots for players or food trucks on game days (30 potential spaces).
- 49 Park gateway element (columns and banners) create arrival space. Place park "rules" sign on columns.
- 50 Relocated overhead utility pole.
- 51 380-foot by 220-foot lawn athletic field. Regrade to pitch at 1% towards Beaver Brook. Sample soil and provide options to improve soil structure and drainage. Amend with nutrients, re-seed, and aerate. Field striping for rugby and lacrosse.
- 52 +/- 80-foot by 180-foot temporary ice rink during winter.
- 53 Coordinate with adjacent property owner to plant native, screening shrubs to increase privacy.
- 54 Colorful banners throughout the parks boundaries help to brand the space as an exciting and active destination in the community.

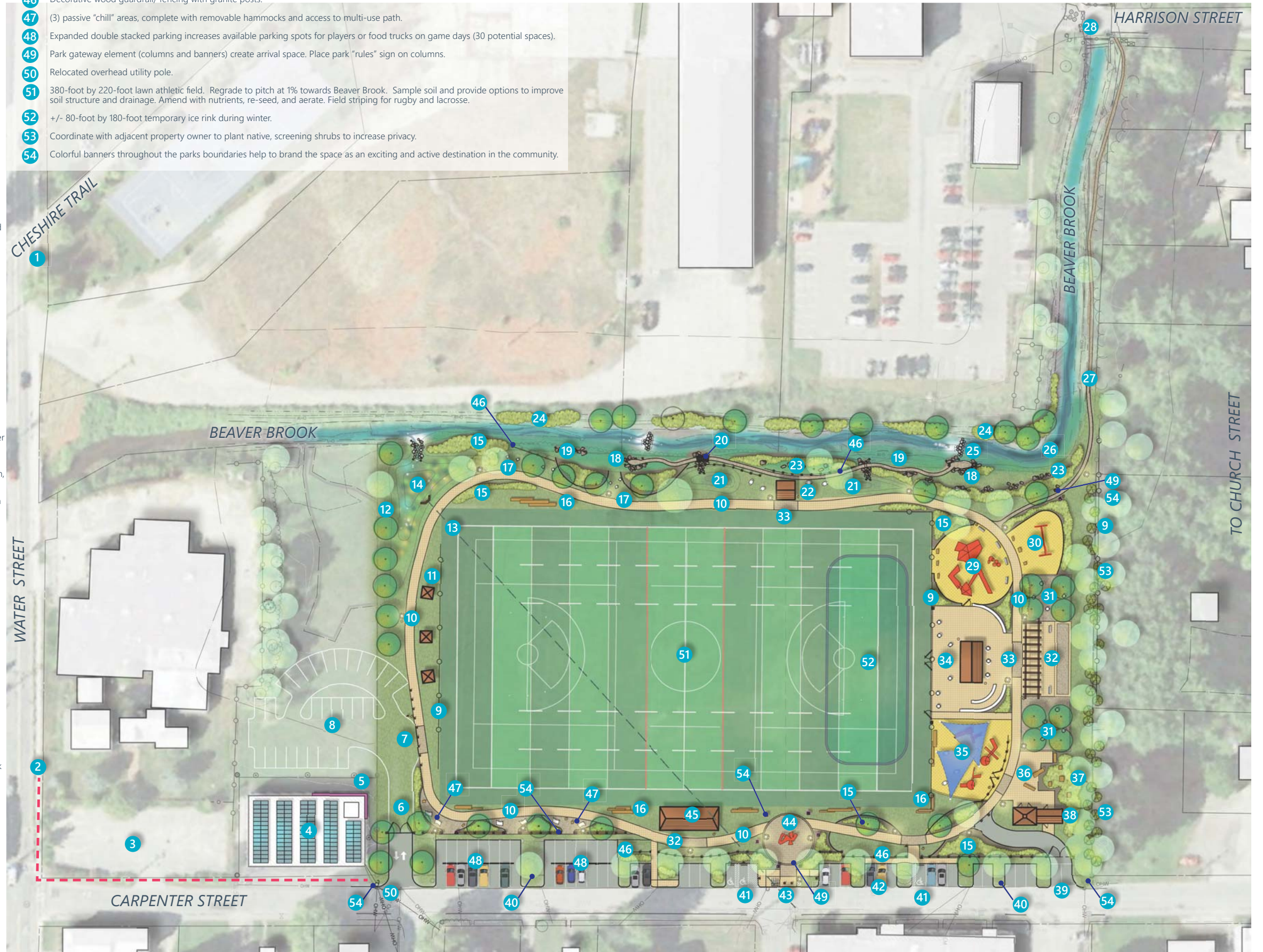
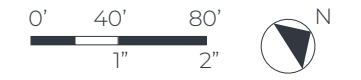

KEENE, NH PATRICIA T. RUSSEL PARK CONCEPT PLAN 1

- 1 Wayfinding signage at Cheshire Rail Trail guides users to the park.
- 2 Existing sidewalk along Water St. provides pedestrian connection between Cheshire Rail Trail and the park.
- 3 Coordinate with property owner to use existing paved parking area for overflow parking during events.
- 4 Mural/ Art installation on existing building (coordinate with building owner).
- 5 Existing open lawn area to remain. Coordinate with building owner to use existing grass area for overflow parking during events.
- 6 Large stormwater infiltration area makes partial use of existing "lawn". Low value wetland area receives stormwater from local pipe buried below athletic field – filtering the adjacent by neighborhoods stormwater prior to entering Beaver Brook.
- 7 Improve the existing low-value wetland by creating a small depression and planting with native wetland plant species. Place educational signage at wetland to teach visitors the benefits of conservation.
- 8 +/- 70-foot by 100-foot play scape area.
- 9 Elevated play pavilion with connecting bridge for views to field or brook.
- 10 Protected existing Linden Trees along Carpenter St. and remove those in poor condition.
- 11 Create a small rain garden below playground tower.
- 12 Permeable paving parking stalls (35 spaces).
- 13 Drop off/ potential food truck parking area.
- 14 Entry plaza with seating area and charging station.
- 15 New chain-link fencing.
- 16 Restroom building and plaza space with benches.
- 17 Butterfly/ pollinator gardens throughout park.
- 18 Multi-level giant tree/log "backless" seating elements.
- 19 Colorful shade sails above bleacher system.
- 20 Picnic areas in lawn adjacent to pavilion (potential separate team/ player areas)
- 21 Open-aired destination pavilion between bleachers.
- 22 Main handicapped-accessible park entrance. Provide signage, detectable warning strips, removable bollards (for emergency access), and a bike rack.
- 23 Accessible parking areas.
- 24 New formalized asphalt parking spaces with flush islands to protect existing trees (36 spaces).
- 25 New formalized asphalt or gravel parking area.
- 26 Park gateway element (modern light poles and banners) create arrival space.
- 27 8-foot wide multi-use trail moves on the outskirts of the park – experiencing multiple use areas.
- 28 +/- 70-foot by 130-foot play area with swings.
- 29 Picnic area surrounded by large flowering shrubs for screening adjacent property and short shrubs in front for sight lines into park.
- 30 Large boulder terrace for sitting and climbing.
- 31 Elevated picnic area with tables and umbrellas.
- 32 Lounge chairs set into hill slope/ sledding hill.
- 33 Seating/ retaining walls with art elements.
- 34 Staircase to access elevated picnic and overlook area.
- 35 Pathway intersection plaza bordered by low retaining walls.
- 36 Passive "chill" areas, complete with hammocks with access to multi-use path and new accessible path surrounded by large flowering shrubs for screening adjacent property.
- 37 New ADA accessible walkway into park.
- 38 Pedestrian wayfinding signage on Harrison Street guides visitors to eastern park access.
- 39 Lower stone pathway to waters edges and connecting to boardwalk.
- 40 Cobble riffles in the stream channel reduce turbidity, slow water velocity, and oxygenates brook for aquatic species.
- 41 Creation of a floodplain island allows flood water to spread and channelize, slowing velocities during rain events and provide a lower riparian tier for new herbaceous communities – as well as welcoming adventurer's looking to get closer to the water.
- 42 Stepping stones.
- 43 Low infiltration areas and created floodplain for added storm water storage and habitat.
- 44 Sediment forebay with high level overflow through cobble rip-rap into adjacent infiltration area and on to Beaver Brook.
- 45 Re-graded hillside lessens severity of steep banks. Place boulders, surrounded by vegetation, on hillside for seating for the adventurous explorer.
- 46 Boardwalk over drainage way with interpretive signage.
- 47 New improved buried stormwater pipe.

- 48 Adirondack seating in lawn areas under new trees and plantings.
- 49 Passive "chill" area, with colorful seating options overlooking the water.
- 50 Decorative wood guardrail/ fencing.
- 51 Boardwalk overlook over created micro floodplain.
- 52 Proposed field lighting.
- 53 400-foot by 220-foot lawn athletic field. Regrade to pitch at 1% towards Beaver Brook. Sample soil and provide options to improve structure and drainage. Amend with nutrients, re-seed, and aerate.
- 54 Field striping for rugby and lacrosse.
- 55 Section of trail trough existing woods.

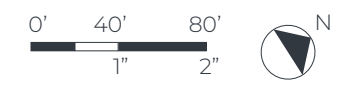

KEENE, NH PATRICIA T. RUSSEL PARK CONCEPT PLAN 2



CHECK OUT OUR CONCEPTS

WE NEED YOUR HELP AGAIN!

DECEMBER 12, 2020 - DECEMBER 31, 2020

PATRICIA T. RUSSELL PARK
PUBLIC INVOLVEMENT PLAN
YOUR PARK, YOUR SAY!



<https://arcg.is/1nPH4f1>



STAFF REPORT

S-08-20 – BOUNDARY LINE ADJUSTMENT – 88 MAIN ST & 0 COMMERCIAL ST

Request: Applicant and owner Colonial Theatre Group Inc. proposes a boundary line adjustment between their property located at 89 Main Street (TMP# 575-008-000) and 0 Commercial Street (TMP# 575-010-000), which is owned by the City of Keene, NH. This adjustment would result in a transfer of 0.01-acres (370.5 sf) from the 1.6-acre lot located at 0 Commercial Street to the 0.36-acre lot located at 89 Main Street. Both properties are located in the Central Business District. The applicant is requesting a waiver from Standard III.C.5.b of the Planning Board’s Site Plan and Subdivision Regulations that requires a survey plan showing all metes and bounds of the revised parcels be submitted as part of a boundary line adjustment application.

Background:

The Colonial Theatre has received approval from the Planning Board and Historic District Commission to build an addition to the rear (west-facing elevation) of the existing building at 89 Main St. This addition will require the construction and installation of underground structural foundation components (e.g. footings, pile caps and mat slabs) on land at 0 Commercial St, which is to the north and west of the Colonial’s existing property boundaries and is owned by the City of Keene. This land is currently used for the Commercial Street Parking Lot, and includes Commercial Street off of Main Street.

The proposed boundary line adjustment would transfer 370.5-sf (0.01-acres) from the parcel at 0 Commercial Street to the property at 89 Main Street to ensure that all above- and below-ground components of the Colonial Theatre’s addition are located on their property. The proposed adjustment would move the western property boundary of 89 Main Street 3-ft to the west, and the northern boundary line 3-ft to the north for a ~54-ft segment of this boundary line starting at the northwestern most corner of the property (see image below).

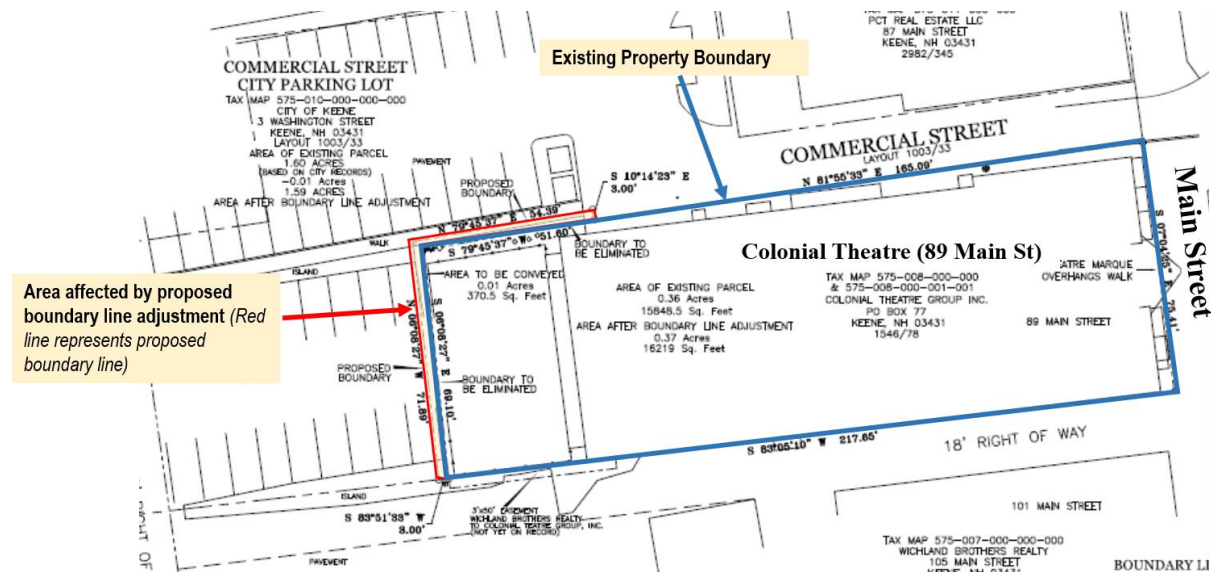

The table below provides the area of each lot prior to and after the proposed adjustment. There are no minimum lot size requirements in the Central Business District. Both lots would satisfy the requirements of zoning if the proposed adjustment were to be approved.

Table 1. Area of Land Affected by Proposed Boundary Line Adjustment		
	89 Main St (TMP# 575-008-000)	0 Commercial St (TMP# 575-010-000)
Prior to Adjustment	15,848.5 sf (0.36 acres)	69,696 sf (1.6 acres)
After Adjustment	16,219 sf (0.37 acres)	69,325.5 sf (1.59 acres)

Completeness:

The Applicant is requesting a waiver from Standard III.C.5.b of the Planning Board’s Site Plan and Subdivision Regulations that requires a survey plan show all metes and bounds of the revised parcels. Specifically, the Applicant is seeking a waiver from providing the full metes and bounds of the property at 0 Commercial Street. The portion of the parcel at 0 Commercial Street impacted by the proposed adjustment is displayed on the plans submitted by the applicant. The full metes and bounds for the property at 89 Main Street are displayed on the submitted plan.

The Applicant has requested exemptions from providing a separate grading plan, landscaping plan, lighting plan, and technical reports. After reviewing this request, Staff has determined that exempting the Applicant from submitting this information would have no bearing on the merits of the application, and recommend that the Board accept the application as “complete.”

Departmental Comments:

There were no departmental comments on this application.

Application Analysis:

The analysis provided below is focused on the Planning Board’s development standards most relevant to this application.

- 3. Hillsides: No steep slopes are present. This standard is not applicable.
- 5. Flooding: Neither parcel is located in the 100-year floodplain. This standard is not applicable.
- 13. Comprehensive Access Management: There is a City-owned sidewalk that runs along a portion of the north-side of the Colonial’s property. If this proposed boundary line adjustment were to be approved, a portion of this sidewalk would become a part of the property at 89 Main Street. The City of Keene is working with the owners of the Colonial Theatre to ensure that the City will preserve the rights to maintain this area as a public sidewalk. If any easements are required to preserve the City’s rights to access the sidewalk space, as well as the Commercial Street parking area, City staff are recommending that documentation of such easements be required as a conditional of approval.

16 & 17. Wetlands & Surface Waters: No wetlands or surface waters are proposed to be impacted by this application. This standard is not applicable.

RECOMMENDATION FOR APPLICATION:

If the Board is inclined to approve the Application, the following motion is recommended:

Approve S-08-20, as shown on the plan identified as “Boundary Line Adjustment Plan Prepared for City of Keene and Colonial Theatre Group, Inc., City of Keene, County of Cheshire, State of New Hampshire” prepared by David Mann Survey at a scale of 1” = 20’ on December 1, 2020 and last revised on December 8, 2020 with the following conditions prior to signature by the Planning Board Chair:

- 1. Owners’ signature appears on plan.**
- 2. Documentation of any necessary easements or agreements between the City of Keene and the Colonial Theatre Group Inc. shall be submitted to the Community Development Department.**

3-08-20

CITY OF KEENE | PLANNING BOARD BOUNDARY LINE ADJUSTMENT APPLICATION



This form must be filled out in its entirety. If a box is not checked, staff will assume that the information is not provided and the application is therefore, not complete. Incomplete applications will not be accepted for review.

A	Project Name Colonial Theatre Addition	Date Received/Date of Submission	 Community Development Dept File #:
	Tax Map Parcel number(s) 575 - 010 - 000 - 000 - 000 575 - 008 - 000 - 000 - 000		
Project Address: 89 Main Street		A p p l i c a n t	Contact Name/Company: PLEASE PRINT: Colonial Theatre Group, Inc.
Acres/S.F. of Parcel: _____ / 370.5			Address: P.O. Box 77, Keene, NH 03431
Zoning District: central business			Telephone: 357-1233 E-mail: alec.doyle@macolonial.org
			Signature: X Printed Name: Alec Doyle
O w n e r # 1	Name/Company: PLEASE PRINT: City of Keene	O w n e r # 2	Name/Company: PLEASE PRINT: Colonial Theatre Group, Inc.
	Address: 3 Washington Street Keene, NH 03431		Address: P.O. Box 77, Keene, NH 03431
	Telephone: 352-5440 E-mail:		Telephone: SAME AS ABOVE. E-mail:
	Signature: Printed Name: Elizabeth Dragon		Signature: X Printed Name: Alec Doyle

B Descriptive Narrative Including

- | | | |
|--|---|---|
| <input checked="" type="checkbox"/> Type of development | <input type="checkbox"/> Sedimentation Control | <input type="checkbox"/> Scope/scale of development |
| <input checked="" type="checkbox"/> Proposed uses | <input type="checkbox"/> Vegetation | <input type="checkbox"/> Parcel size |
| <input type="checkbox"/> Location of access points | <input type="checkbox"/> Debris management | <input type="checkbox"/> Proposed stormwater, drainage & erosion plan |
| <input type="checkbox"/> Any other descriptive information | <input type="checkbox"/> Disposal proposals for boulders, stumps & debris | |

C A complete application must include the following

- | | |
|---|---|
| <input type="checkbox"/> Two (2) copies of completed application forms signed and dated | <input type="checkbox"/> Three (3) copies of "D" size architectural elevations (24" x 36") |
| <input type="checkbox"/> Two (2) copies of descriptive narrative | <input type="checkbox"/> Plans stamped/signed by reg. professional |
| <input type="checkbox"/> Notarized list of all owners of property within 200' - include owner and applicant | <input type="checkbox"/> Two (2) copies on |
| <input type="checkbox"/> Two (2) sets of mailing labels, per abutter | <input type="checkbox"/> Three (3) copies of all technical reports |
| <input type="checkbox"/> Seven (7) copies on "D" size paper of plans (24" x 36") | <input type="checkbox"/> Two (2) color architectural elevations on 11" x 17" |
| | <input type="checkbox"/> A check to cover the costs of legal notice to advertise the public hearing and mailing notices out to abutters |

**BOUNDARY LINE ADJUSTMENT APPLICATION
DESCRIPTIVE NARRATIVE**

The City of Keene ("City") and Colonial Theatre Group, Inc. ("Colonial"), seek in this Boundary Line Adjustment Application a small (370.5 square foot) boundary line adjustment between their abutting parcels. See Plan (the "Plan") entitle "BOUNDARY LINE ADJUSTMENT PLAN PREPARE FOR THE CITY OF KEENE AND COLONIAL THEATRE GROUP, INC." dated December 1, 2020 as part of this Application. The Plan is both an "Existing Conditions Plan" (Section IV.D.2.f.2) and a "Proposed Condition Plan" (Section IV.D.2.f.3).

The City's real estate is located west of Main Street and south of Gilbo Avenue, and consists of parking areas, access roads (including Commercial Street), sidewalks and pedestrian access, collectively referred to here as the "Commercial Street Parking Lot." The Colonial's real estate is located at 89 Main Street, on the west side of Main Street and includes the Colonial Theatre building ("Theatre building"). The Theatre building takes up most of the Colonial's real estate, with its west or back end located about fifty (50) feet from the west boundary of the Colonial real estate. The west and north boundary of the Colonial's real estate abuts the Commercial Street Parking Lot.

As noted on the Plan, 370.5 square feet is the area subject to the proposed Boundary Line Adjustment; the total area of the Colonial real estate prior to the proposed Boundary Adjustment is 15,848.5 square feet; after the boundary adjustment, the total square footage of the Colonial real estate would be 16,219 square feet.

The need for the Boundary Line Adjustment arises because the Colonial is constructing an addition (the "Project") connecting to the west end of the Theatre building. The Planning Board approved a site plan for the Project on September 23, 2019. The Colonial is now in final preparations prior to commencing construction on the Project.

The Project requires construction and installation of underground structural foundation components ("Foundation Components"), including footings, pile caps and mat slabs, over the existing western and northern boundary of the Colonial real estate, onto the Commercial Street Parking Lot.

The City has agreed to an adjustment of the west boundary and a portion of the north boundary three (3) feet from the existing boundaries so that the Foundation Components for the Project will be on the Colonial real estate.

The area subject to the Boundary Line Adjustment is flat and substantially, if not completely, impervious paved asphalt surface. After installation of the underground Foundation Components, the area will be restored to its present condition and there would be no change in conditions and no further development of the area.

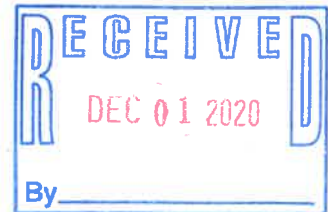

J-08-20
Page 19 of 42

Applicant requests the Planning Director exempt this Application from the following specific submission requirements associated with plan sets and technical reports because of the narrow and limited nature of this Application, and because such requirements are not necessary for the Planning Board's reasonable evaluation of the Application and not necessary for property documentation of the project:

- "Grading Plan" (Section IV.D.2.f.4);
- "Landscaping Plan" (Section IV.D.2.f.5);
- "Lighting Plan" (Section IV.D.2.f.6);
- "Technical Reports" (Section IV.D.2.g); and
- "Additional Technical Reports" (Section IV.D.2.g).

**ADDENDUM TO BOUNDARY LINE ADJUSTMENT APPLICATION
DESCRIPTIVE NARRATIVE**

WAIVER REQUEST

A WAIVER IS REQUESTED UNDER Section X.1 of the Planning Board Regulations from Section III, C. 5-b. of the Planning Board Site Plan and Subdivision Regulations which requires a survey plan showing all metes and bounds of the revised parcels be submitted as part of a boundary line adjustment application. Applicant seeks a waiver from this standard relative to providing a full survey of the City of Keene Commercial Street Parking Lot.

a) Granting the waiver will not be contrary to the spirit and intent of these regulations.

The Commercial Street Parking Lot is listed on City Tax records as 1.6 acres and is made up of the large parking lot (behind the Margarita's restaurant) south of Gilbo Avenue, and related access ways. The portion of this 1.6 acre parcel to be conveyed to applicant is surveyed as part of the application and contains only 370.5 square feet, and this area will not affect the use of the remaining 1.6 acre parcel after approval. Given the large cost involved with surveying the remaining City parcel for this boundary line adjustment, granting the waiver would not be contrary to the spirit and intent of these regulations.

b) Granting the waiver will not increase the potential for creating adverse impacts to abutters, the community or the environment.

The area of the proposed boundary line adjustment will be restored to its present condition after installation of underground foundation components, there would be no additional change in conditions and no further development of the area. Thus, granting the waiver will not increase the potential for creating adverse impacts.

c) Granting the waiver has not been shown to diminish the property values of abutting properties.

The area of the proposed boundary line adjustment will be restored to its present condition after installation of underground foundation components, there would be no additional change in conditions and no further development of the area. Thus, granting the waiver will not diminish property values of abutting properties.

d) Strict conformity with the regulations would pose an unnecessary hardship to the applicant.

Given the large cost involved with surveying the remaining City parcel for this boundary line adjustment and that such a survey is not necessary to the Board's reasonable evaluation of the application, strict conformity with the regulations would pose an unnecessary hardship to applicant.

APPROVED BY THE
 KEENE PLANNING BOARD on _____
 CERTIFIED BY CHAIRMAN _____

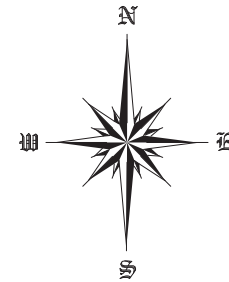
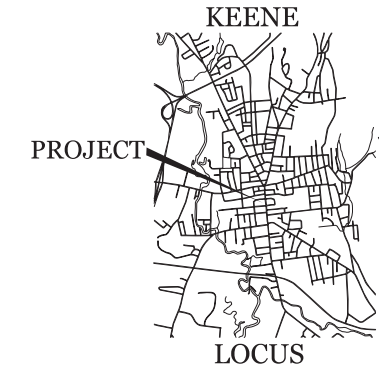

NOTES

- BEARINGS ARE BASED ON X90D-OPUS OBSERVATION AND ARE NEW HAMPSHIRE STATE PLANE GRID NORTH.
- PLAN REFERENCES:
 - PLAN OF LATON MARTIN HOMESTEAD, PREPARED BY SAMUEL WADSWORTH, RECORDED IN PLAN BOOK 13 PAGE 21A.
 - PLAN FRED H. HAMBLET, PREPARED BY ROY K. PIPER AUGUST 1969, FILED IN PIPER RECORDS COR.
 - PARCEL OF LAND CITY OF KEENE TO WJ & MT BISHOP, PREPARED BY KED, PLAN #51-2.
 - SMALL PLANS BOOK, PAGE 8 KED MAP ROOM PREPARED BY KED.
- ASSESSOR INFORMATION BASED ON TOWN RECORDS:

TAX MAP 575-008-000-000
 & 575-008-000-001-001
 COLONIAL THEATRE GROUP INC.
 PO BOX 77
 KEENE, NH 03431
 1546/78

OWNERS CERTIFICATION:

I CERTIFY THAT I AM THE OWNER OF THIS PROPERTY AND THAT I APPROVE OF THIS BOUNDARY ADJUSTMENT.

 CITY OF KEENE

 COLONIAL THEATRE GROUP INC.

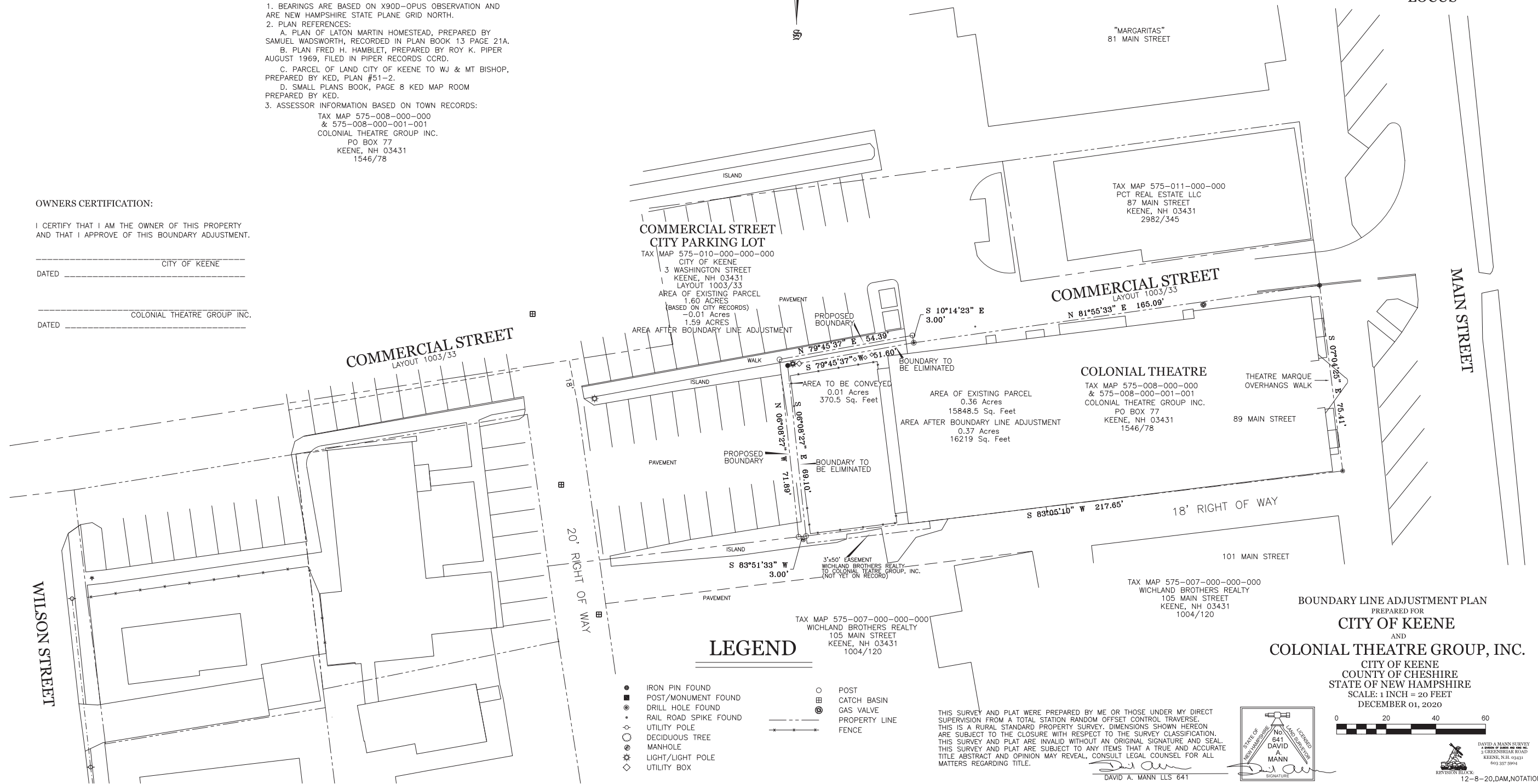

LEGEND

- IRON PIN FOUND
- POST
- POST/MONUMENT FOUND
- CATCH BASIN
- DRILL HOLE FOUND
- ⊗ GAS VALVE
- RAIL ROAD SPIKE FOUND
- ⊕ PROPERTY LINE
- UTILITY POLE
- ⊖ FENCE
- DECIDUOUS TREE
- MANHOLE
- LIGHT/LIGHT POLE
- UTILITY BOX

THIS SURVEY AND PLAT WERE PREPARED BY ME OR THOSE UNDER MY DIRECT SUPERVISION FROM A TOTAL STATION-RANDOM OFFSET CONTROL TRAVERSE. THIS IS A RURAL STANDARD PROPERTY SURVEY. DIMENSIONS SHOWN HEREON ARE SUBJECT TO THE CLOSURE WITH RESPECT TO THE SURVEY CLASSIFICATION. THIS SURVEY AND PLAT ARE INVALID WITHOUT AN ORIGINAL SIGNATURE AND SEAL. THIS SURVEY AND PLAT ARE SUBJECT TO ANY ITEMS THAT A TRUE AND ACCURATE TITLE ABSTRACT AND OPINION MAY REVEAL. CONSULT LEGAL COUNSEL FOR ALL MATTERS REGARDING TITLE.

DAVID A. MANN LLS 641

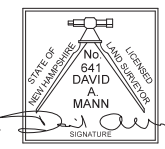

BOUNDARY LINE ADJUSTMENT PLAN
 PREPARED FOR
CITY OF KEENE
 AND
COLONIAL THEATRE GROUP, INC.
 CITY OF KEENE
 COUNTY OF CHESHIRE
 STATE OF NEW HAMPSHIRE
 SCALE: 1 INCH = 20 FEET
 DECEMBER 01, 2020



DAVID A. MANN SURVEY
 4 GREENBRIAR ROAD
 KEENE, N.H. 03431
 603.357.3944
 12-8--20,DAM,NOTATIONS

STAFF REPORT

SPR-878, Modification #1 –SITE PLAN REVIEW – Addition to Noyes Volkswagen, 18 Production Avenue

Request:

Applicant and owner 18 Production Ave. LLC proposes a 3,690-sf single-story addition to the existing, 11,270-sf Noyes Volkswagen building located at 18 Production Ave (TMP# 110-004-000). The site is 2.14 acres in size and is located in the Industrial District.

Background:

This property is located in the Industrial District approximately 0.15 miles south of NH Route 9. The site is currently used as a car dealership and is bordered by a Hyundai dealership to the north, an Eversource facility to the west, Lehmen Industrial Services to the south, and a field to the east. Ash Swamp Brook is located about 0.1 miles to the west.

This site is legally non-conforming with respect to pavement setbacks (see ZBA Notice of Decision ZBA-13-05, attached). In addition, the site is legally non-conforming with respect to its use as a motor vehicle dealership (see ZBA Notice of Decision ZBA-98-18, attached). The Applicant received approval from the ZBA for an Enlargement of a Nonconforming Use at their meeting on December 7, 2020 (see ZBA Notice of Decision ZBA-20-27, attached).

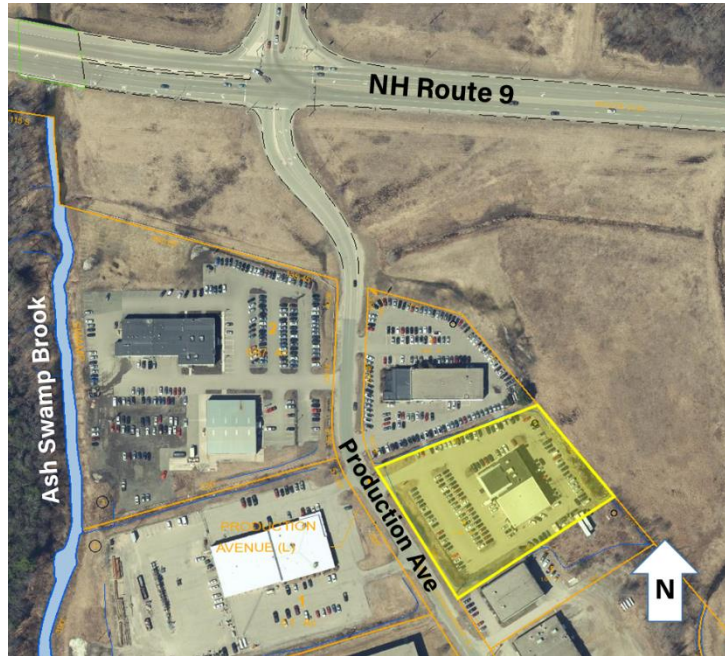

The Applicant received approval from the ZBA for an Enlargement of a Nonconforming Use at their meeting on December 7, 2020 (see ZBA Notice of Decision ZBA-20-27, attached).

The proposal is to construct a 3,690-sf, single story addition on the southeast side of the existing 11,270-sf building in order to provide three new service bays and additional storage area.

Completeness:

The Applicant requests exemptions from providing building elevations that have been prepared and stamped by an architect registered in the State of NH, a lighting plan, a drainage report, and a traffic report. Staff recommend that the board grant these exemptions and accept the application as “complete.”

Departmental Comments:

There were no comments on this application from Fire, Police, Code Enforcement, or Engineering staff.

Application Analysis: The following is a review of the Planning Board development standards relevant to this application.

1. **Drainage:** The proposed addition would be located in a paved area that is currently used for parking and a travel aisle. The Applicant notes in the project narrative that there will be no increase in impervious surfaces as a result of this proposal, and that there will be no increase in runoff. This standard appears to be met.
2. **Sedimentation and Erosion Control:** The Applicant proposes to install silt fencing to the south and east of the area to be disturbed. A detail for silt fencing is included on the proposed site plan. This standard appears to be met.
3. **Hillsides:** There are no steep slopes present on the site. This standard does not apply.
4. **Snow Storage:** Snow storage areas are shown around the perimeter of the site in the unpaved strips of land to the north, east, and south of the paved areas. The Applicant notes in the project narrative that excess snow will be removed from the site. This standard appears to be met.
5. **Flooding:** This property is not located within the 100-year floodplain. This standard does not apply.
6. **Landscaping:** The Applicant proposes to modify the landscaping plan that was originally approved in 2000 as part of SPR-878 to reduce the total number of shrubs and trees on the site. In the project narrative, the Applicant notes that the landscaping has matured over the past 20 years, and although there are fewer plants around the building, these plants fill up the landscaping areas around the building. In addition, the Applicant proposes to replace five Norway maples along Production Avenue which have died with five Red maples. The table below compares the number of plants and trees that were approved in 2000, and the number of plants and trees that are currently proposed. Staff recommend that submittal of a security for landscaping be included as a condition of approval to ensure that the five new trees survive one year.

This standard requires one tree for every ten (10) parking spaces in parking lots of 10 spaces or more. The Applicant proposes to replace five trees that have died, for a total of 12 trees on the site. There are 75 parking spaces for employee and customer parking, and an additional 60 parking spaces for display only (a total 135 parking spaces). Staff recommend that the display parking spaces should not count towards the total number of parking spaces for the purposes of this standard due to their intended use as display parking.

	Approved Landscape Plan (2000)	Proposed Landscape Plan
Trees	18 (Norway Maple)	12 (7 Norway pine, 5 Red Maple)
Arbor Vitae	18	0
Other shrubs	45	28

8. Screening: The Applicant proposes to relocate the existing dumpster and screen it with a 6' high solid wood fence. A detail for the dumpster screening is included on the proposed site plan. This standard appears to be met.
10. Lighting: The Applicant proposes to install three LED, full cut-off wall pack lights, one above each of the egress doors on the east and south sides of the addition and one above the overhead door on the north side of the addition. No other changes to lighting are proposed. This standard appears to be met.
11. Sewer and Water: The Applicant notes that the sewer and water service for the existing building is adequate for the proposed addition, and further states that the existing sprinkler system will be expanded into the addition to provide fire protection. Engineering staff did not express any concerns regarding the impact of this proposal on the capacity of the City sewer or water lines. This standard appears to be met.
12. Traffic: In the project narrative, the Applicant states that this proposal will result in an estimated increase of 30 vehicle trips per day. This estimate was based on the number of new employees (three) and an estimated increase of 15 vehicles that could be serviced per day due to increased capacity from the three new service bays. This increase in traffic generation does not meet the threshold for requiring a traffic study (100 vehicle trips per day); therefore, the Applicant has requested an exemption from providing a traffic report.

With respect to parking, there will be 135 parking spaces provided on the site where 75 are required by zoning. Of these, 60 spaces will be used for display and 75 will be used for customer and employee parking. In addition, two parking spaces in front of the existing building will be designated for electric vehicle charging. This standard appears to be met.

13. Comprehensive Access Management: No changes are proposed to the existing driveway or to pedestrian, bicycle, or public transit facilities. This property is located in an Industrial area where sidewalks, bicycle facilities, and public transit are not currently provided. This standard appears to be met.
15. Filling and Excavation: The Applicant states that this project will result in the removal of ~200 cubic yards of material, which will be replaced with a similar volume of structural gravels. This fill would not impact steep slopes, wetlands, or surface waters. The haul route to and from the site will be via NH Route 9 to Production Avenue. This standard appears to be met.
16. Wetlands: There are no wetlands located on the site or within 30 feet of the proposed development. This standard does not apply.
17. Surface Water: There are no surface waters present on the site. Ash Swamp Brook is located approximately 0.1 miles (about 580 feet) to the west of the site. This standard does not apply.
19. Architecture and Visual Appearance: The proposed new addition would match the appearance of the existing building in terms of height and the color and material of the siding, which is metal siding in a "Cool Cotton White" color with metal trim. There will be one egress door on the south elevation, one egress door on the east elevation, and an overhead door on the north elevation. No door or window openings are proposed on the west elevation (facing Production Avenue).

The Applicant submitted building elevation drawings, which are attached to this staff report, as well as photos to show what the existing building looks like. These photos are included below, and are also shown on the proposed site plan.



PHOTO 1



PHOTO 2



PHOTO 3

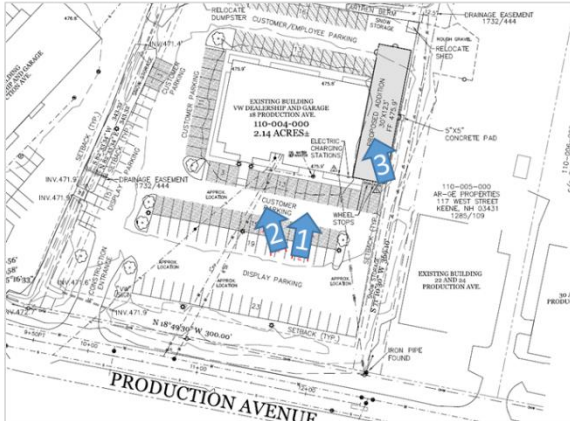

IMAGE / EXCERPT OF PROPOSED SITE PLAN

Recommended Motion:

If the Board is inclined to approve this request, the following motion is recommended:

Approve SPR-878, Modification #1 for the construction of a 3,690-sf single-story addition to the existing, 11,270-sf Noyes Volkswagen building located at 18 Production Ave (TMP# 110-004-000), as depicted on the site plan identified as “Addition to Noyes Volkswagen, Inc.” prepared by Brickstone Land Use Consultants at a scale of 1 inch = 40 feet, dated November 9, 2020 and last revised on December 1, 2020 with the following conditions prior to signature by Planning Board chair:

1. Submittal of a security for landscaping in an amount acceptable to the City Engineer and Community Development Director.

CITY OF KEENE | PLANNING BOARD

SITE PLAN REVIEW / MODIFICATION APPLICATION



This form must be filled out in its entirety. If a box is not checked, staff will assume that the information is not provided and the application is, therefore, not complete. Incomplete applications will not be accepted for review.

A Project Name Addition to Noyes Volkswagen Tax Map Parcel number(s) 110-004-000-_____ _____ _____	Date Received/Date of Submission: _____ Date of pre-application meeting: _____ Date Application is Complete: _____ Community Development Dept File #: _____	
	Project Address: 18 Production Ave Acreage/S.F. of Parcel: 2.14 +/- / 93,343 +/-	O w n e r
Zoning District: Industrial	A p p l i c a n t	PRINTED Name: Robert Noyes Signature: <i>[Signature]</i> Address: 18 Production Ave Keene NH Telephone\ Email: _____

Modifications: Is this a modification to a previously-approved site plan: No Yes: SPR#: 878 Date: 1998

For those sections of the application that are not affected by the proposed modification to the previously approved site plan, you are encouraged to request exemptions in lieu of submitting required documents.

B Descriptive Narrative Including

- | | | |
|---|---|--|
| <input checked="" type="checkbox"/> Type of development | <input checked="" type="checkbox"/> Sedimentation Control | <input checked="" type="checkbox"/> Scope/scale of development |
| <input checked="" type="checkbox"/> Proposed uses | <input checked="" type="checkbox"/> Vegetation | <input checked="" type="checkbox"/> Parcel size |
| <input checked="" type="checkbox"/> Location of access points | N/A <input type="checkbox"/> Debris management | <input checked="" type="checkbox"/> Proposed stormwater, drainage & erosion plan |
| <input checked="" type="checkbox"/> Any other descriptive information | N/A <input type="checkbox"/> Disposal proposals for boulders, stumps & debris | |

C A complete application must include the following

**Site Plan Review Application Narrative
Modification #1 to SPR- 878
Additions to Noyes Volkswagen of Keene
18 Production Avenue
Keene, NH**

**November 12, 2020
Revised 12-02-2020**

Project Narrative

18 Production Ave, LLC is the owner of TMP 110-004-000, a 2.14 acre site located at 18 Production Avenue. The property is in the Industrial District and is currently occupied by Noyes Volkswagen in an existing 11,270 sf building. The property is existing nonconforming for pavement setbacks for which a variance was granted in 2013, ZBA 13-05.

The owner wishes to build a 3690 sf addition to the south side of the existing building on an area which is currently paved and part of the existing parking area. The 30' x 123' addition will provide three additional service bays and additional storage for the motor vehicle dealership.

The addition will match the existing building materials and building colors with white metal siding and white metal trim. Approximately 15 existing parking spaces will be eliminated, and three new spaces will be added, which will leave 135 parking spaces where 75 spaces are required by zoning. The existing dumpster and enclosure will be relocated on the lot.

Up to three new employees are planned at this time but there will be no changes to the existing hours of operation.

The landscaping on the site has been revised and updated to reflect the existing mature plants which are now 20 years old. Five trees along Production Ave. were lost and are being replaced with new plantings.

No other changes to the previously approved site plan are proposed. Exemptions are requested from providing information not applicable or not present on the site. This includes an exemption from providing a drainage report since there will be no changes to the existing runoff; no new lighting plan since the only new lights will be the egress door lights and one wall pac over the overhead door; and no traffic report since only three new employees are planned and there will be no changes to the hours of operation.

**Site Plan Review Application Narrative
Modification #1 to SPR-878
Addition to Noyes Volkswagen
81 Production Avenue
Keene, NH**

**November 13, 2020
Revised Dec. 01, 2020**

Development Standards

1. **Drainage** - No changes proposed. The proposed addition is located on an existing paved area to the south side of the building. There will be no increase in runoff as a result. The drainage patterns on the property remain the same. An exemption from providing a drainage report is requested.
2. **Sediment/Erosion Control** – Silt fence will be installed along the south sides of the area where the addition will be built. There are no catch basins in that area.
3. **Hillside Protection** - N/A
4. **Snow Storage and Removal** – No changes are proposed. Snow will be stored adjacent to the paved parking areas. Excess snow will be removed from the site.
5. **Flooding** - This site is in Zone X and is not subject to flooding in a 100 year event.
6. **Landscaping** – An up-to-date landscape plan is attached. The original plantings at this site are now 20 years old. The plants at the site have matured nicely and are now much larger than when they were planted 20 years ago. As such, there are fewer plants next to the building than shown on the original site plan. The existing plants are all healthy, so no new shrubs are proposed. The trees that were called for next to Production Avenue have all died, so we are calling for 5 new trees to replace them: 3 Red Maples and 2 Norway Maples. No additional changes are proposed. We are requesting the Planning Board approve this modified landscape plan in place of the original landscape plan from 2000. The mature plants have filled the planting beds adjacent to the building, and no additional plantings are necessary.
7. **Noise** - N/A
8. **Screening** – The existing dumpster will be relocated to the northeast corner of the site and will be enclosed with solid fencing 6' in height.
9. **Air Quality** – N/A

- 10. Lighting** – One small wall mounted LED, full cutoff fixture will be added over the new overhead door on the north side of the addition to the rear of the existing building. As required by code, one small wall mounted LED, full cutoff fixture will also be added over the two new egress doors on the east and south walls of the proposed addition. Lumark, Xtor Crosstour LED lights will be used. A manufacturer's cut sheet is provided. An exemption is requested from providing a photometric lighting plan for these small fixtures. No changes are proposed to the parking lot lighting.
- 11. Sewer and Water** – The existing sewer and water services are adequate to support the proposed building addition. The existing sprinkler system will be expanded into the new addition and is sized adequately to provide the required fire protection.
- 12. Traffic** – The proposed addition will result in up to three new employees being hired. There will also be a slight increase in customer traffic as three new service bays will allow for increased customer traffic. We estimate that up to 15 additional vehicles will be serviced per day, resulting in 30 additional vehicle trips per day. This small amount of additional traffic can easily be accommodated through the signalized intersection of Production Avenue and Rt. 9 and will not result in a significant impact to the safety or capacity of the intersection. An exemption is requested from providing a traffic report.
- 13. Driveways** – No changes proposed. The existing paved driveway will serve as the construction entrance during the construction of the addition.
- 14. Hazardous and Toxic Materials** – The owner has no knowledge of contaminants present on this site.
- 15. Filling/Excavation** – The proposed addition will result in approximately 200 CY of material to be removed from the site and replaced with a similar amount of structural gravels. The haul route to and from the site is Rt. 9 to Production Avenue.
- 16. Wetlands** – N/A
- 17. Surface Waters** – Ash Swamp Brook is located approximately 600 feet to the west of the site. It will not be affected by this proposal.
- 18. Stump Dumps** – None
- 19. Architecture and Visual Appearance** – The proposed addition will match the existing metal siding and metal trim on the existing building. The wall panels are from Varco Pruden Buildings and the color will be Cool Cotton White to match the existing building. The addition will be 21 feet in height to match the existing building height. The addition will have an industrial appearance which matches

the other buildings on Production Avenue. See site plan for color photos of the existing building along with the attached color sheet from the manufacturer.

LEGEND

- IRON PIN TO BE SET
- IRON PIN FOUND
- * HYDRANT
- ⋈ SIGN
- UTILITY POLE
- + GUY
- ⊠ CATCH BASIN
- WATER VALVE
- SEWER MANHOLE
- SEWER CLEANOUT
- CURB STOP
- EASEMENT LINE
- SETBACK LINE
- W --- WATER LINE
- S --- SEWER LINE
- UG --- UNDERGROUND UTILITY LINE

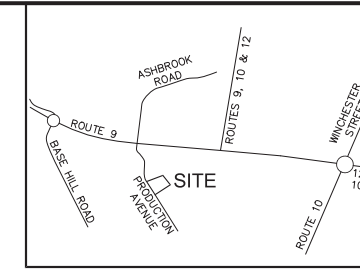

REVISIONS:

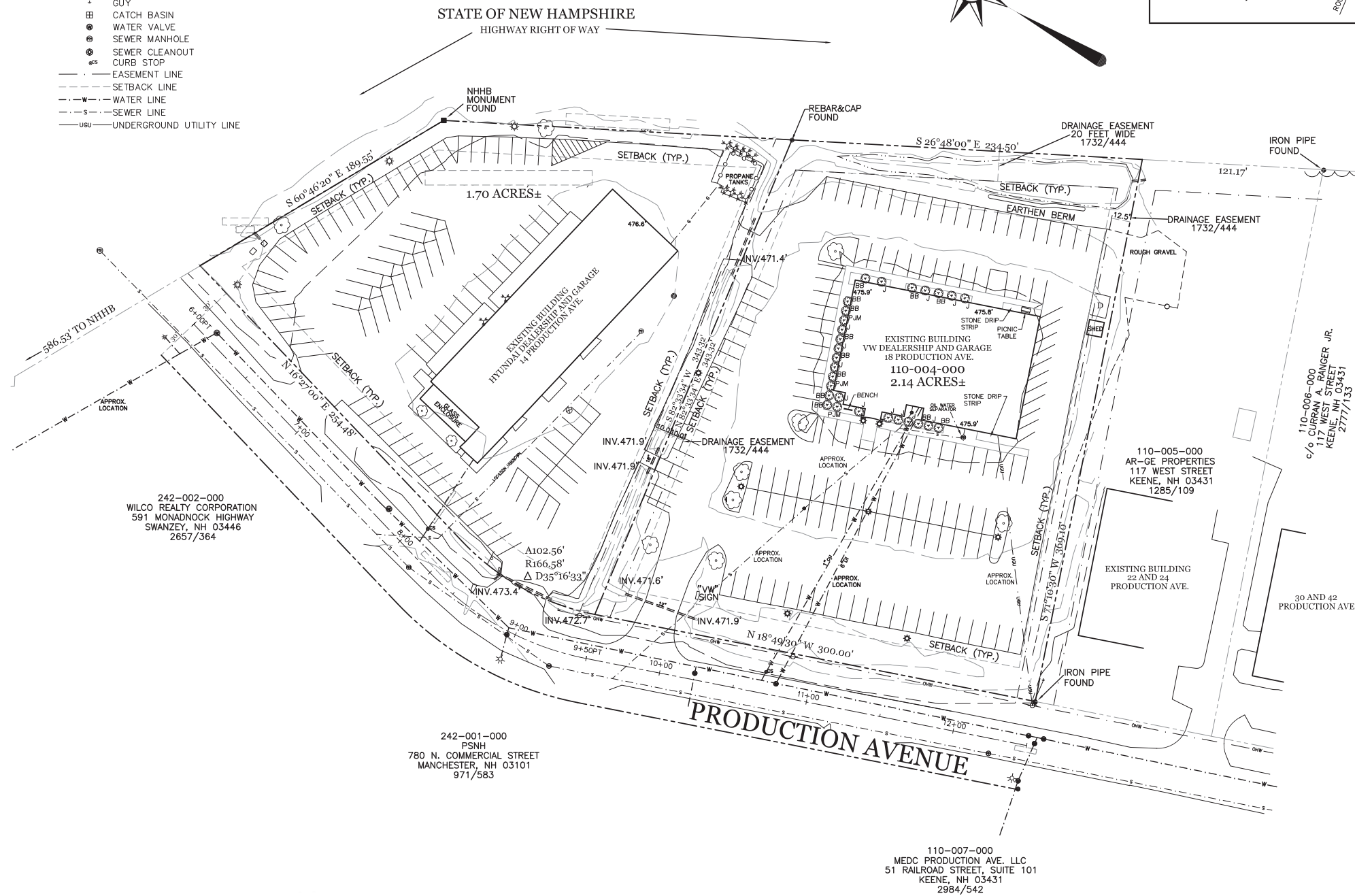

242-002-000
WILCO REALTY CORPORATION
591 MONADNOCK HIGHWAY
SWANZEE, NH 03446
2657/364

242-001-000
PSNH
780 N. COMMERCIAL STREET
MANCHESTER, NH 03101
971/583

110-007-000
MEDC PRODUCTION AVE. LLC
51 RAILROAD STREET, SUITE 101
KEENE, NH 03431
2984/542

OWNERS CERTIFICATION:

I CERTIFY THAT I AM THE OWNER OF THIS PROPERTY
AND THAT I APPROVE OF THIS SITE PLAN.

OWNER: _____

DATED: 11/11/20

OWNER/DEVELOPER:
18 PRODUCTION AVE. LLC
18 PRODUCTION AVE.
KEENE, NH 03431

ENGINEER:
SCT ENGINEERING
189 JORDON ROAD
KEENE, NH 03431

PLANNER:
Brickstone Land Use Consultants, LLC
Site Planning, Permitting and Development Consulting
185 Winchester Street, Keene, NH 03431
Phone: (603) 357-0116

ADDITION TO NOYES
VOLKSWAGEN, INC.
18 PRODUCTION AVENUE
KEENE, NH 03431

EXISTING PLAN

SCALE: 1"=40'

DATE: NOV. 9, 2020

SHEET 1



PHOTO 1



PHOTO 2



PHOTO 3

PICTURES TAKEN
NOVEMBER 2020

LEGEND

- IRON PIN TO BE SET
- IRON PIN FOUND
- * HYDRANT
- † SIGN
- UTILITY POLE
- + GUY
- ⊠ CATCH BASIN
- WATER VALVE
- SEWER MANHOLE
- SEWER CLEANOUT
- CURB STOP
- EASEMENT LINE
- - - SETBACK LINE
- W- WATER LINE
- S- SEWER LINE
- UG- UNDERGROUND UTILITY LINE
- ⌒ PROPOSED WALL MOUNTED LIGHT
- [D] DUMPSTER WITH 6' SOLID FENCING

STATE OF NEW HAMPSHIRE
HIGHWAY RIGHT OF WAY

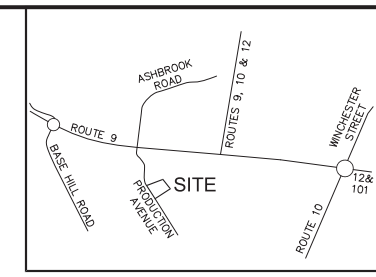
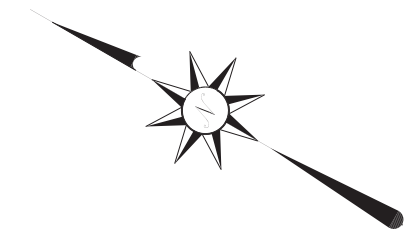

- REVISIONS:**
- ▲ DECEMBER 1, 2020
ADD DETAILS AND ELECTRIC CHARGING STATIONS
 - ▲ DECEMBER 7, 2020
RELOCATE CHARGING STATIONS

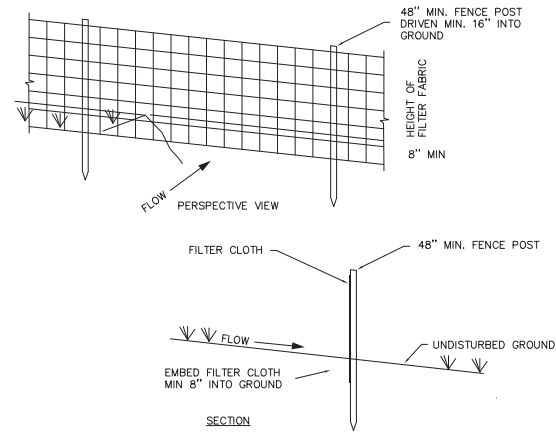
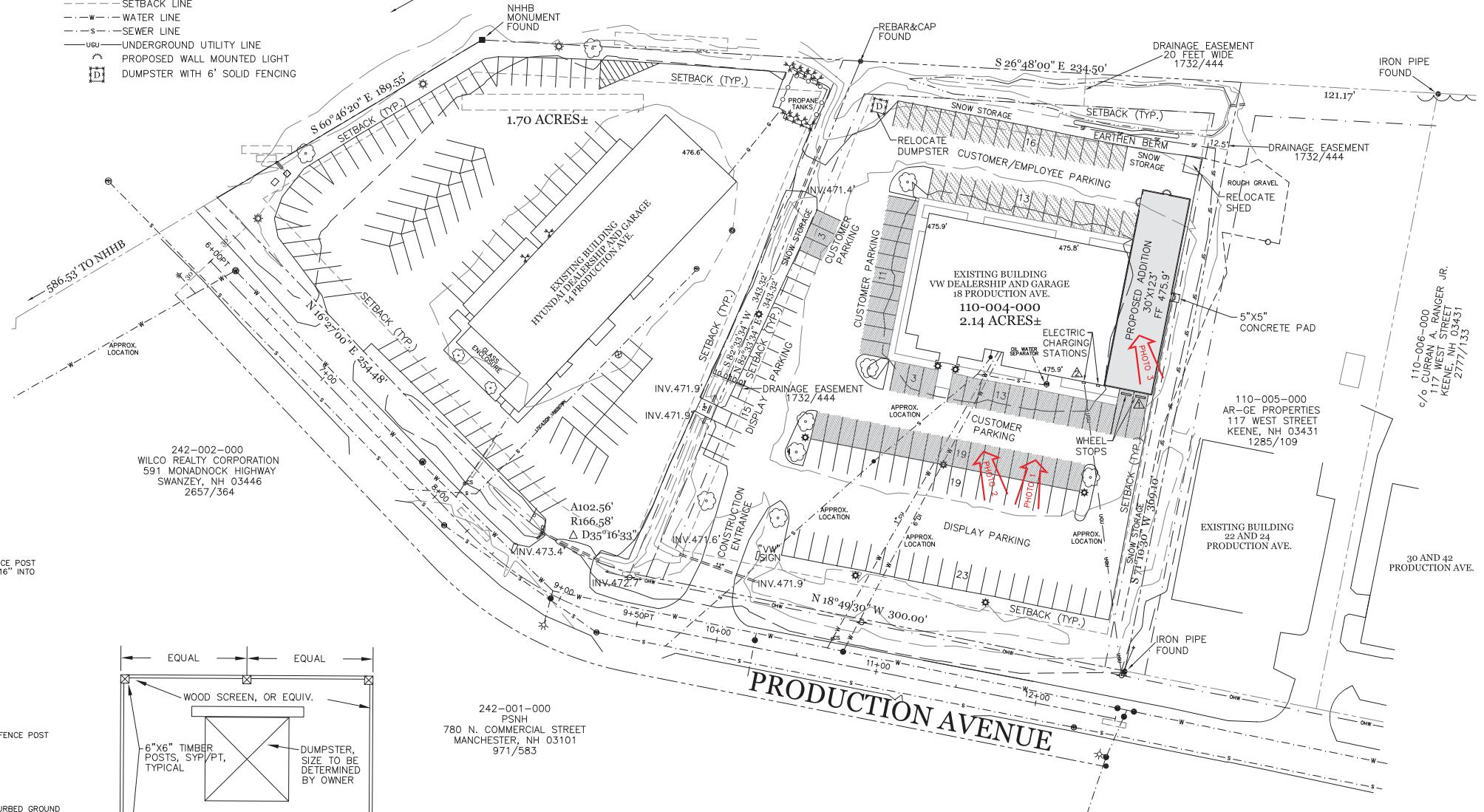

- CONSTRUCTION SPECIFICATIONS**
- FABRIC TO BE FASTENED SECURELY TO FENCE POSTS WITH WIRE TIES OR STAPLES.
 - WHEN TWO SECTIONS OF FILTER CLOTH ADJOIN EACH OTHER, THEY SHALL BE OVERLAPPED AT A POST BY 6 INCHES, FOLDED AND STAPLED.
 - MAINTENANCE SHALL BE PERFORMED AS NEEDED AND MATERIAL REMOVED WHEN "BULGES" DEVELOP IN THE SILT FENCE.

SILT FENCE DETAIL
NTS

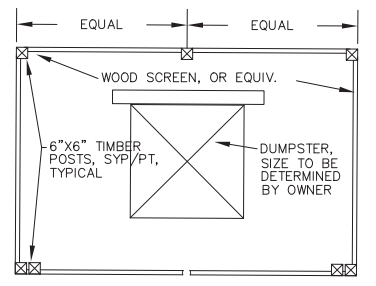

- NOTES:**
- ALL WOOD POSTS TO BE PRESSURE TREATED, FREE FROM EXCESSIVE CRACKS, CHIPS, WARPS OR KNOTS.
 - ALL FASTENERS TO BE HOT DIPPED GALVANIZED.
 - WOOD SCREEN MEMBERS AND GATES TO CONFORM TO DETAIL ELEVATION AS NOTED.
 - DIMENSIONS OF ENCLOSURE TO BE DETERMINED BY OWNER PRIOR TO FABRICATION OR CONSTRUCTION.
 - PROVIDE 4' WIDE ACCESS OPENING ON SIDE, W/ A.D.A. ROUTE.

WOOD DUMPSTER ENCLOSURE
NO SCALE

OWNERS CERTIFICATION:
I CERTIFY THAT I AM THE OWNER OF THIS PROPERTY AND THAT I APPROVE OF THIS SITE PLAN.

OWNER: _____
DATED: 11/11/20

110-007-000
MEDC PRODUCTION AVE. LLC
51 RAILROAD STREET, SUITE 101
KEENE, NH 03431
2984/542

PARKING

- CUSTOMER/EMPLOYEE PARKING
- CUSTOMER PARKING
- DISPLAY PARKING

LOT DATA

ZONING	INDUSTRIAL DISTRICT
TAX MAP #	110-004-000
LOT SIZE	93,343 SF - 2.14 AC±
EXISTING LOT COVERAGE	10,489 SF - 11.2%
BUILDINGS/DECKS	59,082 SF - 63.3%
PAVING/GRAVEL/WALK TOTAL	69,571 SF - 74.5%
PROPOSED LOT COVERAGE	14,179 SF - 15.2%
BUILDINGS/DECKS	55,392 SF - 59.3%
PAVING/GRAVEL/WALK TOTAL	67,571 SF - 74.5%
PARKING PROPOSED	14,920 SF @ 1/200 SF = 75 SPACES REQUIRED
	135 SPACES PROVIDED



OWNER/DEVELOPER:
18 PRODUCTION AVE. LLC
18 PRODUCTION AVE.
KEENE, NH 03431

ENGINEER:
SCT ENGINEERING
189 JORDON ROAD
KEENE, NH 03431

PLANNER:
Brickstone
Land Use Consultants, LLC
Site Planning, Permitting and Development Consulting
185 Winchester Street, Keene, NH 03431
Phone: (603) 357-0116

ADDITION TO NOYES VOLKSWAGEN, INC.
18 PRODUCTION AVENUE
KEENE, NH 03431

PROPOSED PLAN

SCALE: 1"=40'
DATE: NOV. 9, 2020

SHEET 2

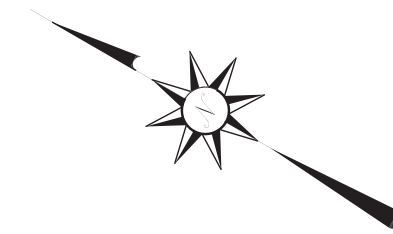
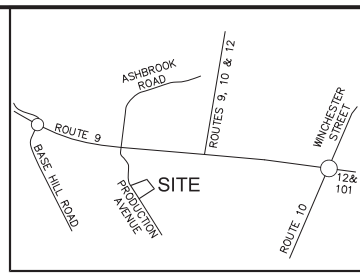

REVISIONS:
 ▲ DECEMBER 1, 2020
 ADD LANDSCAPE PLAN
 ▲ DECEMBER 8, 2020
 REVISE TREES

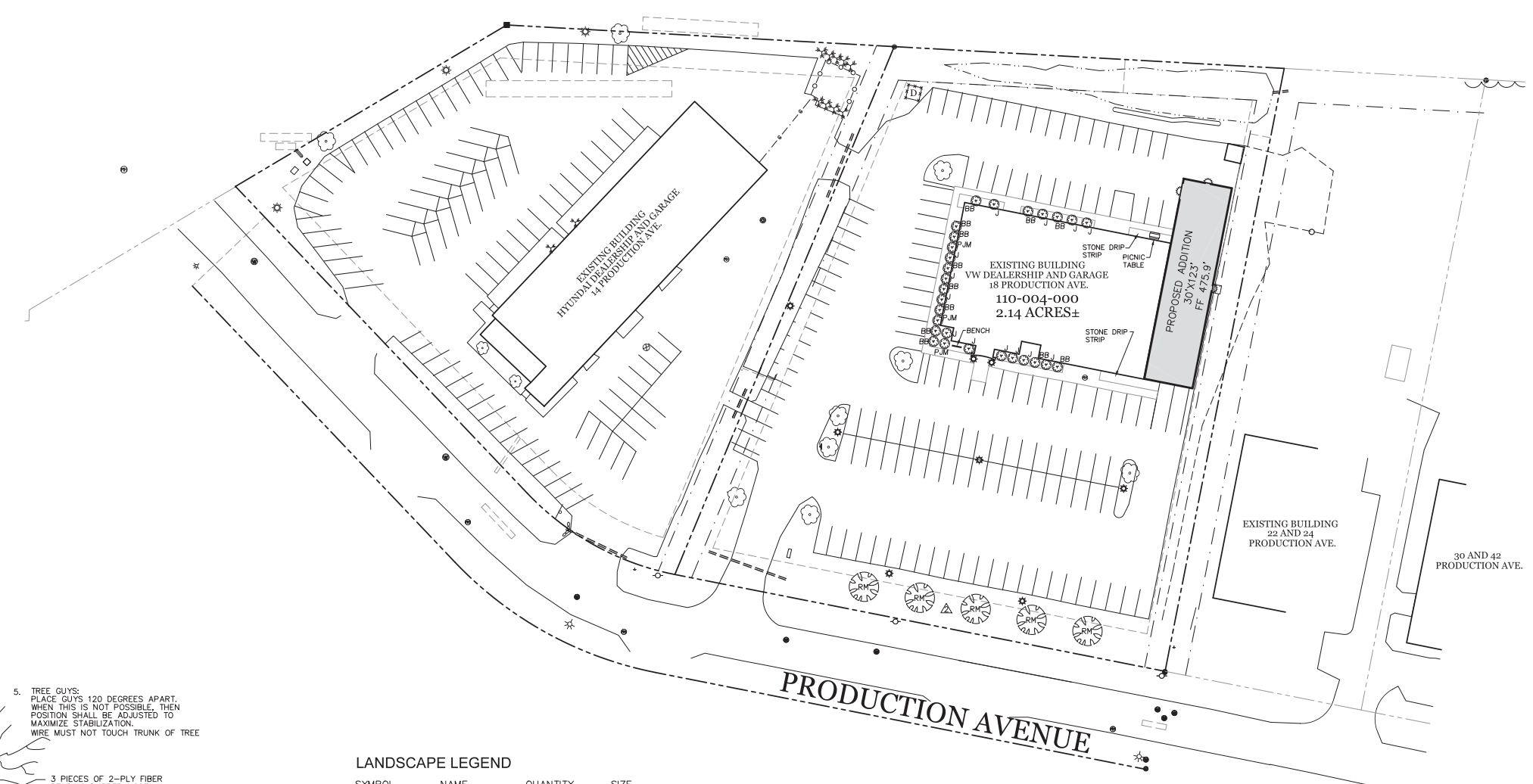

OWNER/DEVELOPER:
 18 PRODUCTION
 AVE. LLC
 18 PRODUCTION AVE.
 KEENE, NH 03431

ENGINEER:
 SCT ENGINEERING
 189 JORDON ROAD
 KEENE, NH 03431

PLANNER:
Brickstone
 Land Use Consultants, LLC
Site Planning, Permitting and Development Consulting
 185 Winchester Street, Keene, NH 03431
 Phone: (603) 357-0116

ADDITION TO NOYES
 VOLKSWAGEN, INC.
 18 PRODUCTIVE AVENUE
 KEENE, NH 03431

LANDSCAPE PLAN

SCALE: 1"=40'

DATE: NOV. 9, 2020

SHEET 3

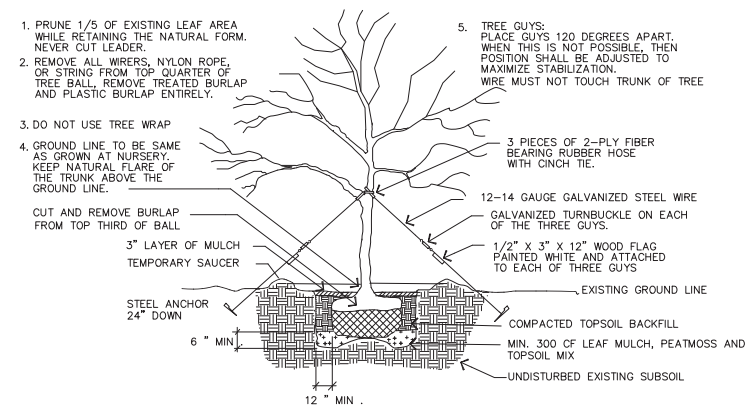

DETAIL OF TREE PLANTING AND GUYING
 NOT TO SCALE

LANDSCAPE LEGEND

SYMBOL	NAME	QUANTITY	SIZE
EXISTING			
	JUNIPER	13	
	PJM	3	
	BURNING BUSH	12	
	NORWAY PINE	7	
PROPOSED			
	RED MAPLE	5	▲ 3" CAL.
	ACER RUBRUM		



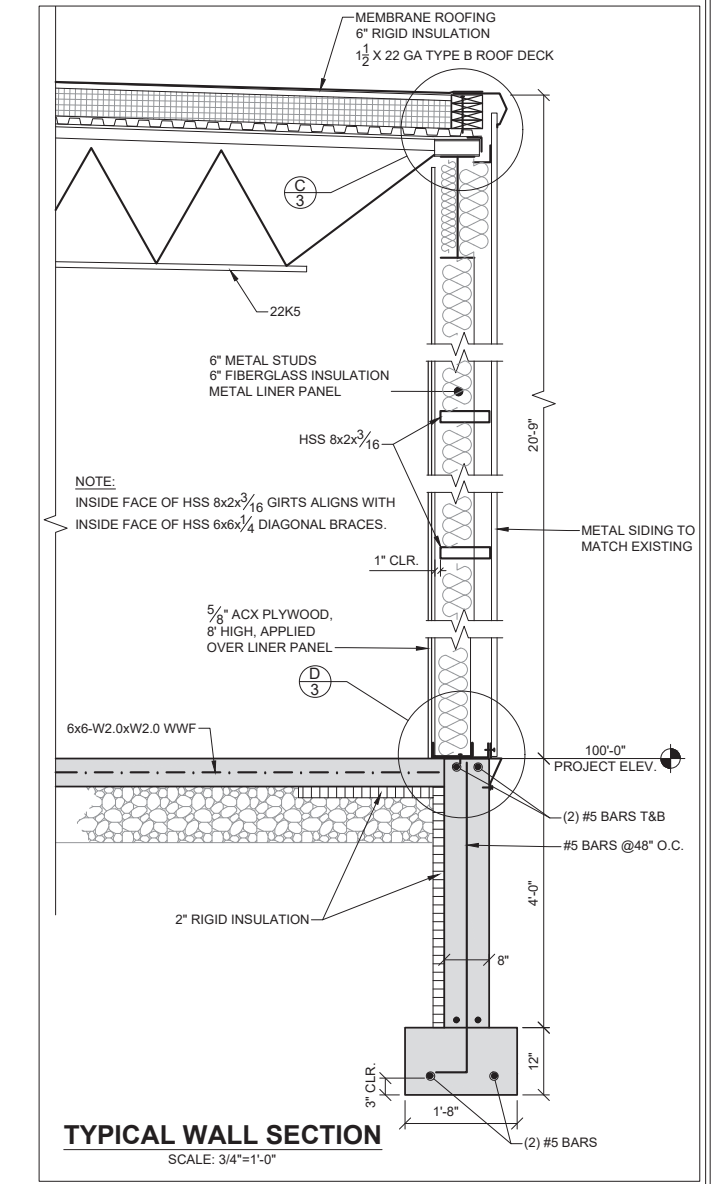
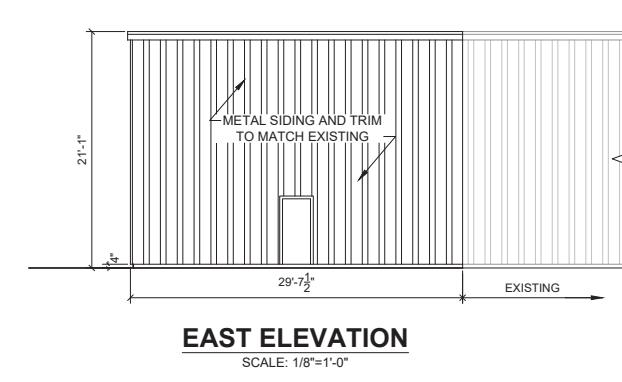
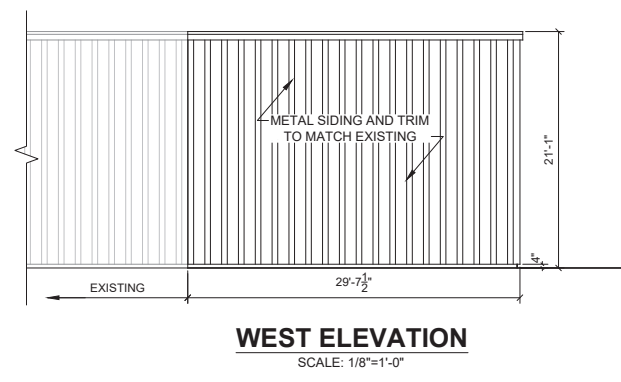
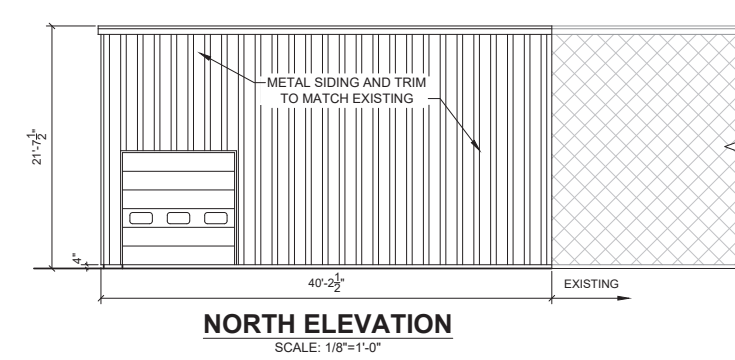
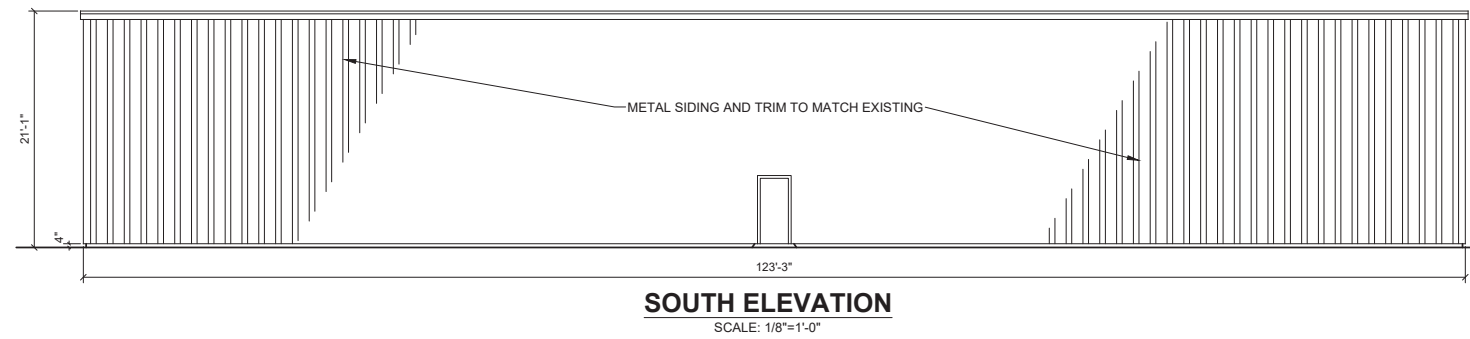
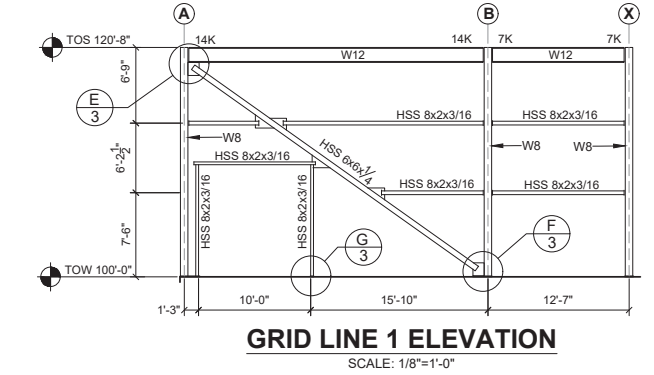
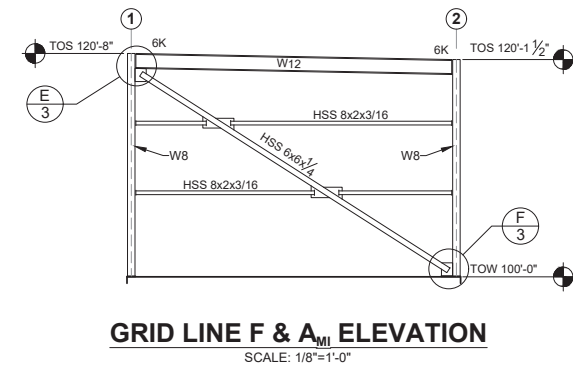
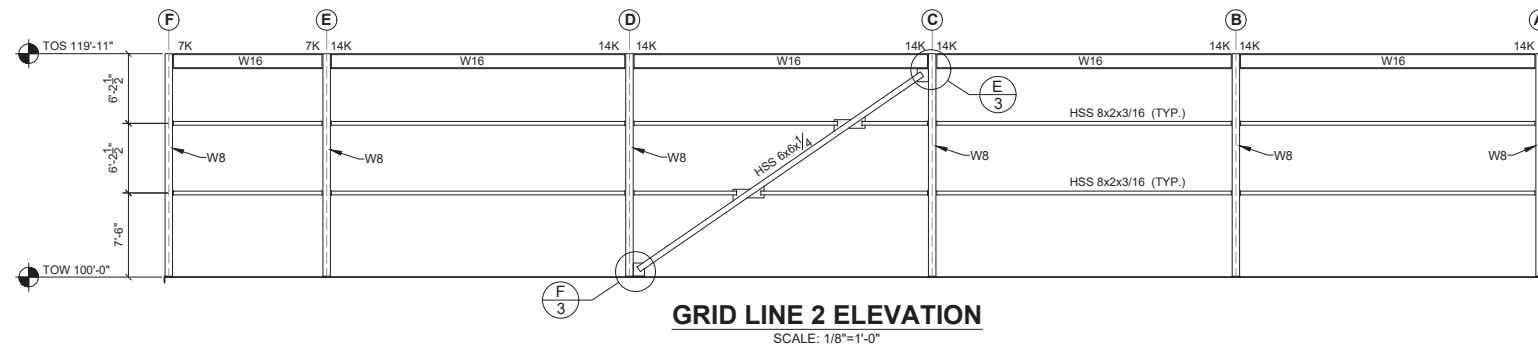

FOR PRICING AND PERMITTING ONLY

REV. #	DESCRIPTION	BY & DATE	CHK. & DATE	REV. #	DESCRIPTION	BY & DATE	CHK. & DATE

DATE SURVEY: N/A
 DATE PLAN: 11/14/20
 DESIGNED BY: SCT
 DRAWN BY: TJS
 CHECKED BY: SCT
 SCALE: AS NOTED

STRUCTURAL DESIGN
 FOR
NOYES VOLKSWAGEN
 18 PRODUCTION AVENUE, KEENE, NEW HAMPSHIRE

SCT Engineering Page 35 of 42
 189 Jordan Road, Keene, NH
 603-352-1488
 www.sctengineering.com

PROJ. NO. K2701
 CAD NO. K2701-01
 SHEET 2 OF 4

DESCRIPTION

The patented Lumark Crosstour™ LED Wall Pack Series of luminaires provides an architectural style with super bright, energy efficient LEDs. The low-profile, rugged die-cast aluminum construction, universal back box, stainless steel hardware along with a sealed and gasketed optical compartment make the Crosstour impervious to contaminants. The Crosstour wall luminaire is ideal for wall/surface, inverted mount for façade/canopy illumination, post/bollard, site lighting, floodlight and low level pathway illumination including stairs. Typical applications include building entrances, multi-use facilities, apartment buildings, institutions, schools, stairways and loading docks test.

SPECIFICATION FEATURES

Construction

Slim, low-profile LED design with rugged one-piece, die-cast aluminum hinged removable door and back box. Matching housing styles incorporate both a small and medium design. The small housing is available in 12W, 18W and 26W. The medium housing is available in the 38W model. Patented secure lock hinge feature allows for safe and easy tool-less electrical connections with the supplied push-in connectors. Back box includes three half-inch, NPT threaded conduit entry points. The universal back box supports both the small and medium forms and mounts to standard 3-1/2" to 4" round and octagonal, 4" square, single gang and masonry junction boxes. Key hole gasket allows for adaptation to junction box or wall. External fin design extracts heat from the fixture surface. One-piece silicone gasket seals door and back box. Minimum 5" wide pole for site lighting application. Not recommended for car wash applications.

Optical

Silicone sealed optical LED chamber incorporates a custom engineered mirrored anodized reflector providing high-efficiency illumination. Optical assembly includes impact-resistant tempered glass and meets IESNA requirements for full cutoff compliance. Available in seven lumen packages; 5000K, 4000K and 3000K CCT.

Electrical

LED driver is mounted to the die-cast housing for optimal heat sinking. LED thermal management system incorporates both conduction and natural convection to transfer heat rapidly away from the LED source. 12W, 18W, 26W and 38W series operate in -40°C to 40°C [-40°F to 104°F]. High ambient 50°C models available. Crosstour luminaires maintain greater than 89% of initial light output after 72,000 hours of operation. Three half-inch NPT threaded conduit entry points allow for thru-branch wiring. Back box is an authorized

Catalog #		Type	
Project		Date	
Comments			
Prepared by			

electrical wiring compartment.

Integral LED electronic driver incorporates surge protection. 120-277V 50/60Hz or 347V 60Hz models.

Finish

Crosstour is protected with a Super durable TGIC carbon bronze or summit white polyester powder coat paint. Super durable TGIC powder coat paint finishes withstand extreme climate conditions while providing optimal color and gloss retention of the installed life.

Warranty

Five-year warranty.



XTOR CROSTOUR LED

APPLICATIONS:
WALL / SURFACE
POST / BOLLARD
LOW LEVEL
FLOODLIGHT
INVERTED
SITE LIGHTING

DIMENSIONS

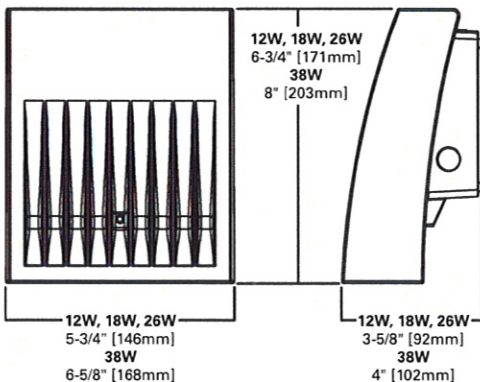

ESCUTCHEON PLATES

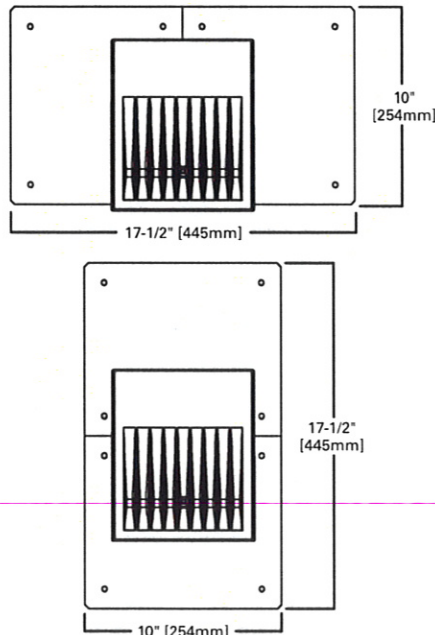

CERTIFICATION DATA
Dark Sky Approved (Fixed mount, Full cutoff, and 3000K CCT only)
UL/cUL Wet Location Listed
LM79 / LM80 Compliant
ROHS Compliant
ADA Compliant
NOM Compliant Models
IP66 Ingress Protection Rated
Title 24 Compliant
DesignLights Consortium® Qualified*

TECHNICAL DATA
40°C Maximum Ambient Temperature
External Supply Wiring 90°C Minimum

EPA
Effective Projected Area (Sq. Ft.):
XTOR1B, XTOR2B, XTOR3B=0.34
XTOR4B=0.45

SHIPPING DATA:
Approximate Net Weight:
3.7 – 5.25 lbs. [1.7 – 2.4 kgs.]



VARCO PRUDEN BUILDINGS

STANDARD WALL, TRIM & ROOF COLORS

Cool Arctic White

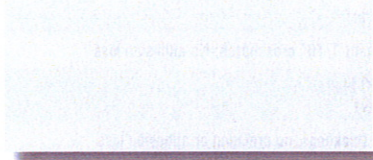

Cool Cotton White

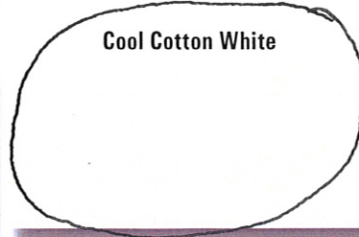

Cool Egyptian White

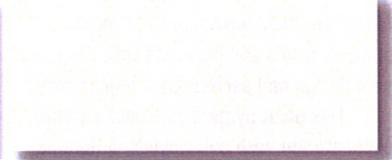

Cool Sierra Tan



Cool Granite Gray

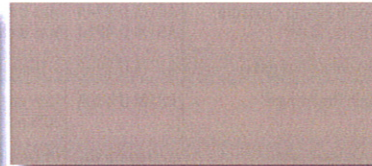

Cool Zinc Gray



Cool Straw Gold

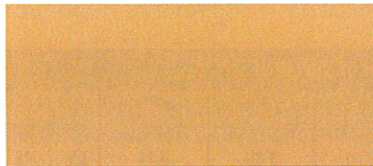

Cool Dark Bronze

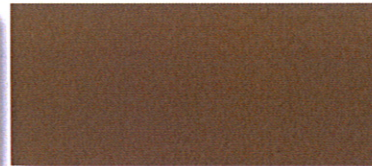

Cool Colonial Red

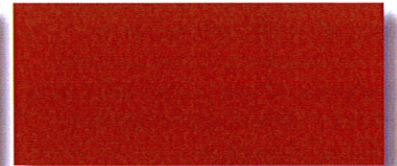

Cool Hemlock Green

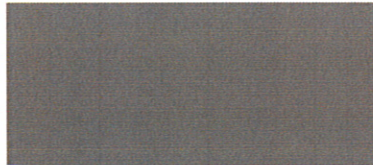

Cool Leaf Green



Cool Bermuda Green



Cool Cobalt Blue

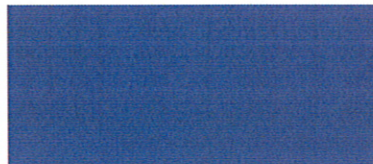

Cool Imperial Blue

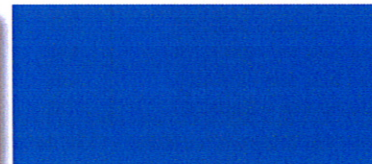

Cool Ebony (trim only)



Acrylic Coated Galvalume*



Wall panel colors for Panel Rib, RPR, Tech Four & Vee Rib. Roof panel colors for Panel Rib Roof and SSR.

Liner panel colors are limited to 24 & 26 gauges. 22 & 28 gauge liner is available in Polyester Interior White finish.

For SLR II colors, see selection card #6020. * Acrylic Coated Galvalume is only available for roof panels & Deck-Liner.

COLORS & FINISHES





MAP SCALE 1" = 500'

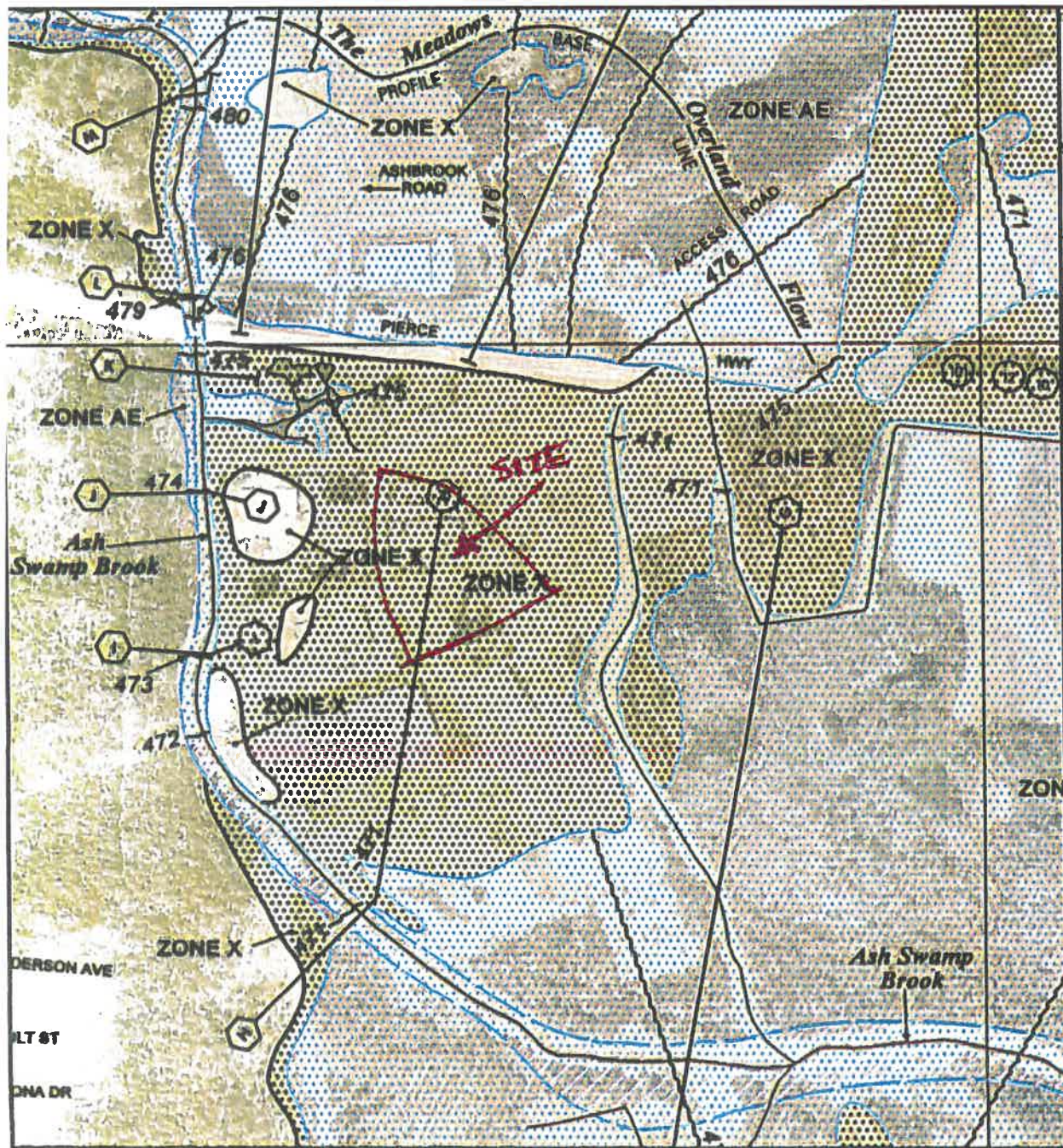

PANEL 0266E

FIRM
FLOOD INSURANCE RATE MAP
CHESHIRE COUNTY,
NEW HAMPSHIRE
(ALL JURISDICTIONS)

PANEL 266 OF 610
(SEE MAP INDEX FOR FIRM PANEL LAYOUT)

CONTAINS:

COMMUNITY	NUMBER	PANEL	SUFFIX
KEENE CITY OF	33000	0000	E
SWANSEY TOWN OF	33000	0000	E

Notice to User: The Map Number shown below should be used when placing map orders; the Community Number shown below should be used on insurance applications for the subject community.

MAP NUMBER
33005C0266E

EFFECTIVE DATE
MAY 23, 2006

Federal Emergency Management Agency

This is an official copy of a portion of the above referenced flood map. It was extracted using FIRM On-Line. This map does not reflect changes or amendments which may have been made subsequent to the date on the title block. For the latest product information about National Flood Insurance Program (NFIP) maps, check the FEMA Flood Map Store at www.msc.fema.gov



City of Keene

New Hampshire

NOTICE OF DECISION March 4th, 2013

ZONING BOARD OF ADJUSTMENT

CASE NUMBER: ZBA 13-05
Property Address: 14-18 Production Ave.
Zone: Industrial Zone
Owner: Fentco Realty Corporation
Petitioner: James Phippard, Brickstone Land Use Consultants, LLC

You are hereby notified that the request for a Variance for property located at 14-18 Production Ave. in the Industrial Zone and based upon the record and which is incorporated by reference has been approved 5-0 by the Board. This approval will allow a two lot subdivision which will result in a lot with a side pavement setback of 3.5 feet where 15 feet is required for commercial parking on a large lot in the Industrial Zone, per Section 102-1226, Setbacks of paved and unpaved parking and travel surfaces.

Conditions: None

Corinne Marcou, Clerk

NOTE: Any person affected has a right to appeal this Decision. If you wish to appeal, you must act within thirty- (30) days of the date of this notice. The necessary first step, before any appeal may be taken to the Courts, is to apply to the Board of Adjustment for a rehearing. The motion for rehearing must set forth all the grounds on which you will be base your appeal. See New Hampshire Statutes, RSA Chapter 677, for details.



City of Keene

3 Washington Street

New Hampshire 03431

NOTICE OF DECISION

November 2, 1998

ZONING BOARD OF ADJUSTMENT

CASE NUMBER: ZBA-98-18
Property Address: 14 Production Avenue, Lots 7 and 8
Zone: Industrial Zone
Petitioner: Jim Phippard for Brickstone Masons, Inc.
Owner: John Bunce

You are hereby notified that the petition for an Enlargement of a Non-Conforming Use at the **November 2, 1998**, meeting was granted by a **5 - 0** vote of the Board.

- CONDITIONS:**
1. **The Enlargement of the Non-Conforming Use will be permitted upon the prior merger of the two lots.**
 2. **The Enlargement of the Non-Conforming Use will be permitted subject to various land use regulations, especially pertaining to wetlands.**



Marcia F. White, Clerk

NOTE: Any person affected has a right to appeal this Decision. If you wish to appeal, you must act within twenty (20) days of the date of this notice. The necessary first step, before any appeal may be taken to the Courts, is to apply to the Board of Adjustment for a rehearing. The motion for rehearing must set forth all the grounds on which you will be base your appeal. See New Hampshire Statutes, RSA Chapter 677, for details.

Phone
Mayor 357-9804 • Manager 357-9804 • Accounting 352-1013 • Airport 357-9835 • Assessor 352-2125 • Attorney 357-9806
Building Maintenance 357-9844 • City Clerk 352-0133 • Equipment Garage 357-9831 • Fire 352-1291 • Health 352-5440 • Human Services 357-9809
Information Management Services 357-9802 • Inspections 352-5440 • Juvenile Conference Committee 357-9810 • Landfill & Recycle/Transfer Station 352-5739
Parks & Recreation 357-9829 • Planning 352-5474 • Police 357-9815 • Public Works 352-6550 • Purchasing 357-9800 • Tax Collector 357-9801
Water Treatment Facility 357-8483 • Wastewater Treatment Plant 357-9836 • Water & Sewer 352-3239

FAX
Airport 357-9853 • Assessor 357-9857 • City Hall 357-9847 • Fire 358-3420 • Landfill & Recycle/Transfer Station 352-8325 • Library 382-1101
Parks & Recreation 357-9859 • Police 357-9823 • Public Works 357-9848 • Wastewater Treatment Plant 357-9854
Area Code 603



NOTICE OF DECISION

ZONING BOARD OF ADJUSTMENT

CASE NUMBER: ZBA 20-27
Property Address: 18 Production Ave.
Zone: Industrial District
Owner: Noyes Volkswagen
Petitioner: Jim Phippard, Brickstone Land Use, LLC
Date of Decision: December 7, 2020

Notification of Decision:

Petitioner, Noyes Volkswagen, of Keene, NH, requested an Enlargement of a Nonconforming Use for property located at 18 Production Ave., Keene, Tax Map #110-004-000, which is in the Industrial District. The Petitioner, which requested an Enlargement of a Nonconforming Use to enlarge the existing motor vehicle dealership by constructing a 3,690 sf building gaddition. The existing Volkswagen building is 10,490 sf plus a 740 mezzanine. This proposal will enlarge the existing building by expanding on the south side with a 30' x 123' addition. The addition will be used for storage and additional service bays, was approved 5-0.

Condition:

Corinne Marcou, Clerk

Any person directly affected has a right to appeal this Decision. The necessary first step, before any appeal may be taken to the courts, is to apply to the Board of Adjustment for a rehearing. The Motion for Rehearing must be filed not later than 30 days after the first date following the referenced Date of Decision. The Motion must fully set forth every ground upon which it is claimed that the decision is unlawful or unreasonable. See New Hampshire RSA Chapter 677, et seq.

cc: Planning Dept.
Assessing Dept.
City Attorney
File Copy



Planning Board

2021 Meeting Schedule

All meetings are on the 4th Monday of each month at 6:30PM, unless otherwise noted with an *

January 25, 2021

February 22, 2021

March 22, 2021

April 26, 2021

May 24, 2021

June 28, 2021

July 26, 2021

August 23, 2021

September 27, 2021

October 25, 2021

November 22, 2021

December 20, 2021*

January 24, 2022